

R

R

R

R

R

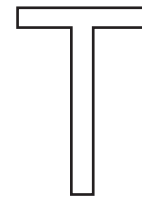
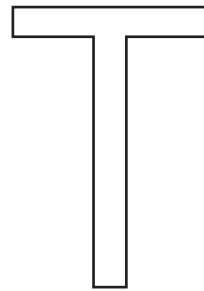
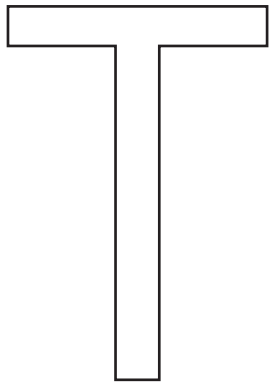
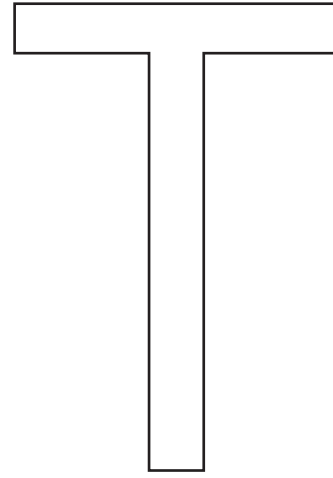
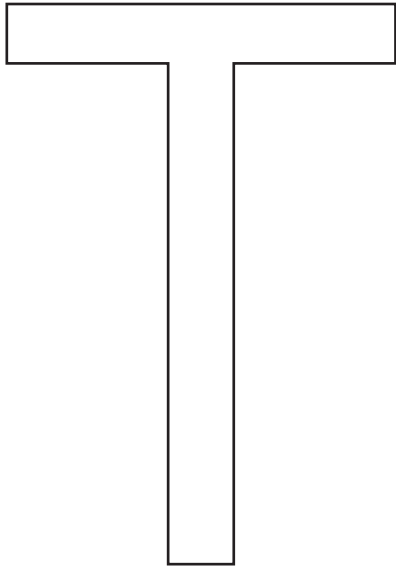

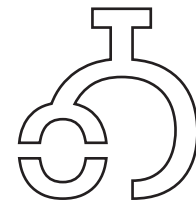
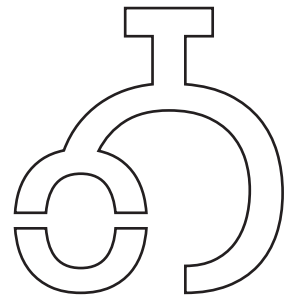
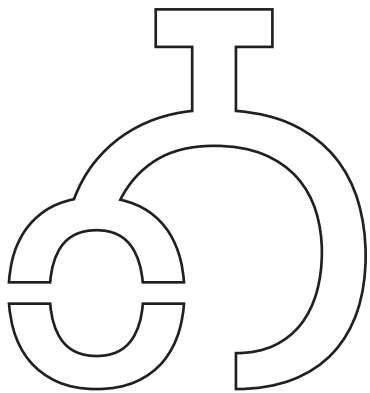
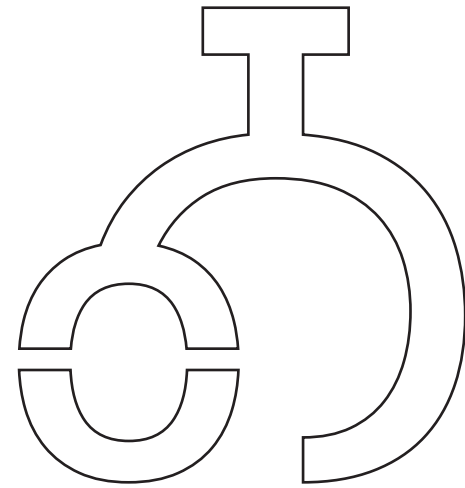
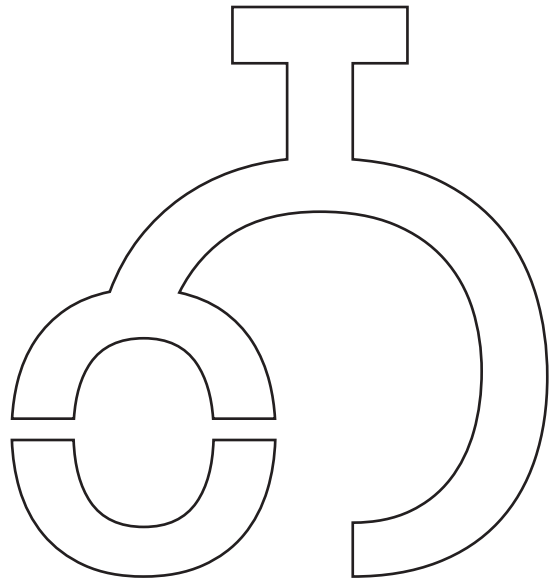



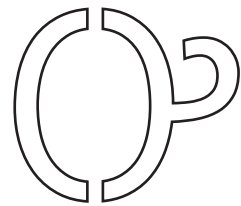
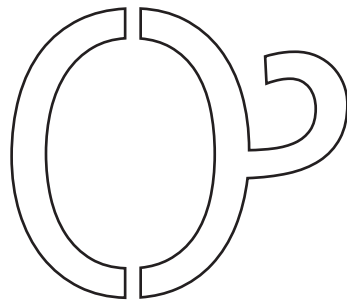
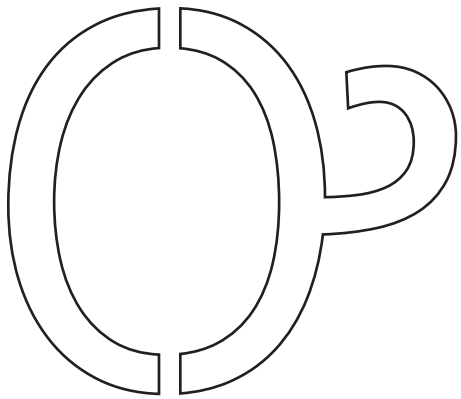
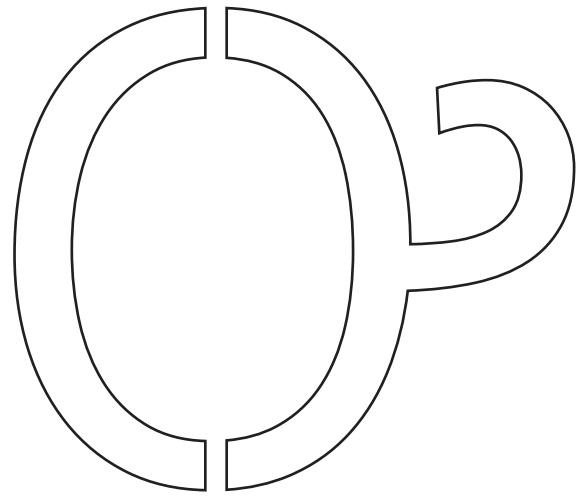
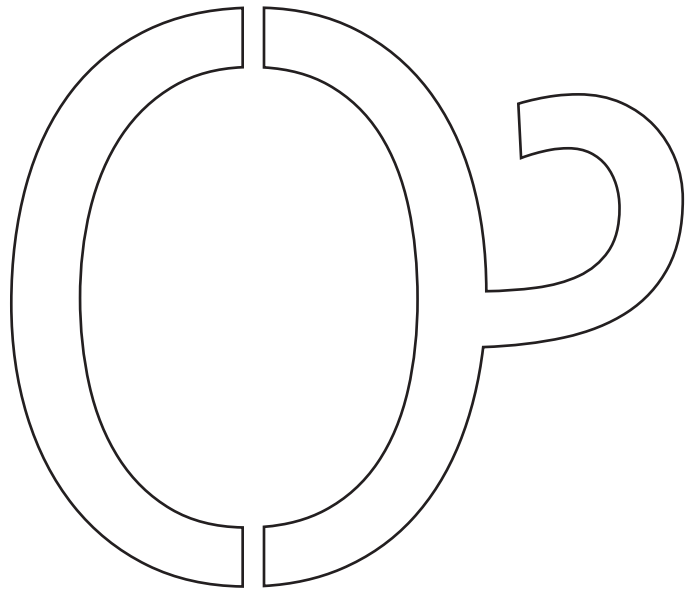

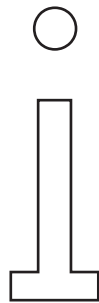
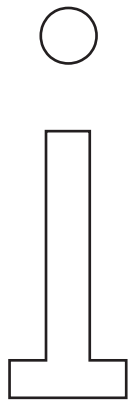
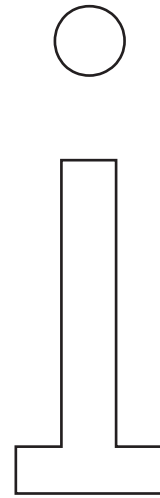
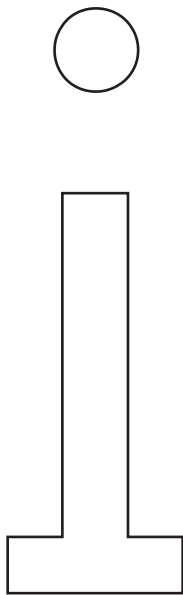

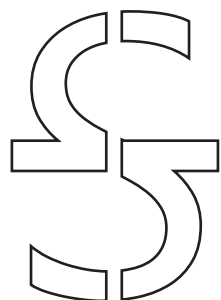
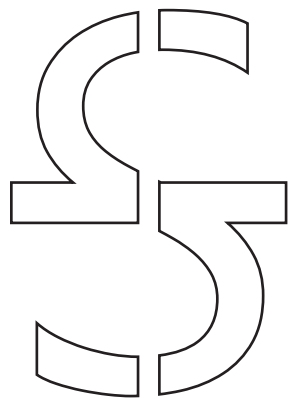
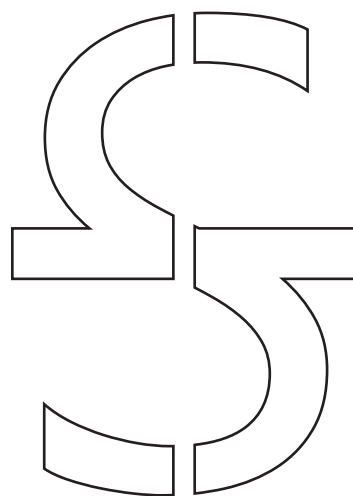
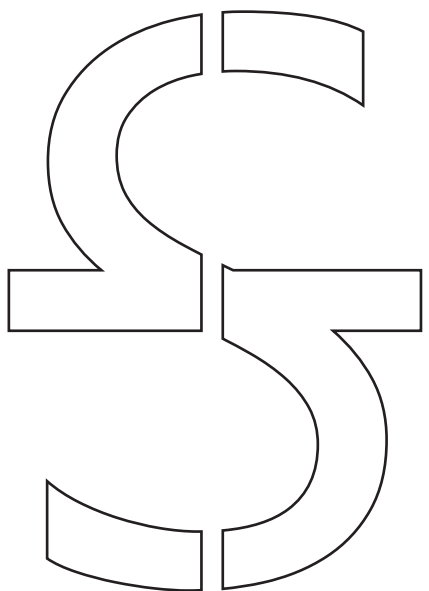

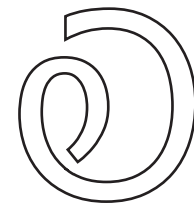
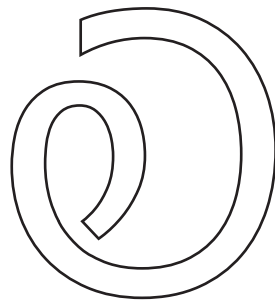
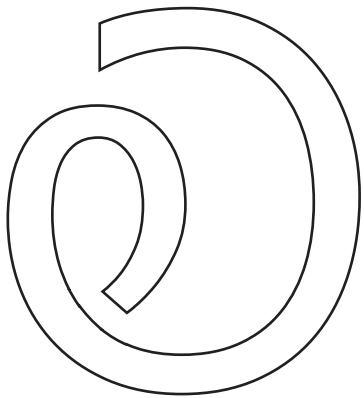
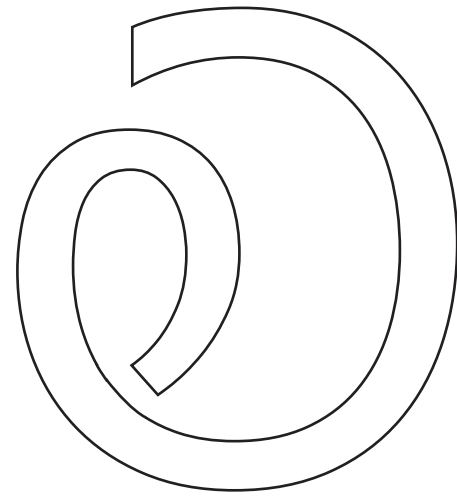
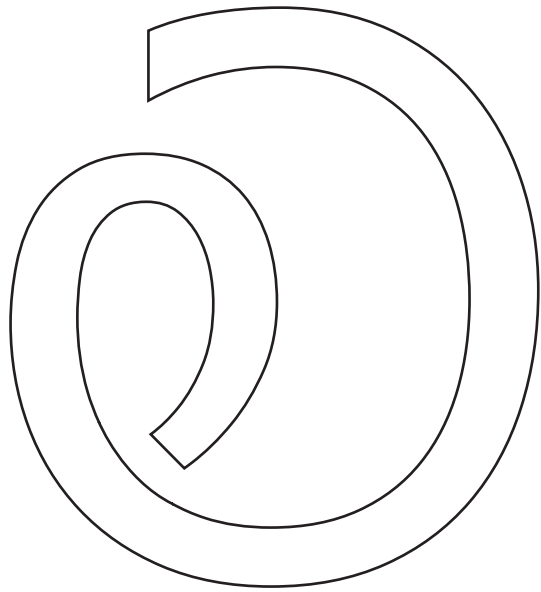

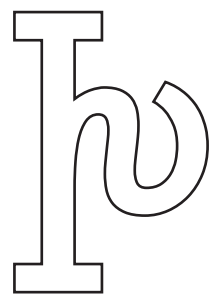
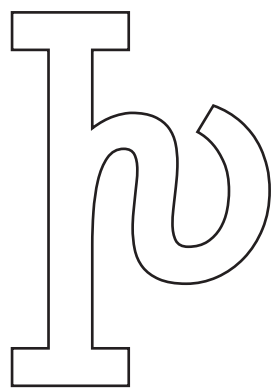
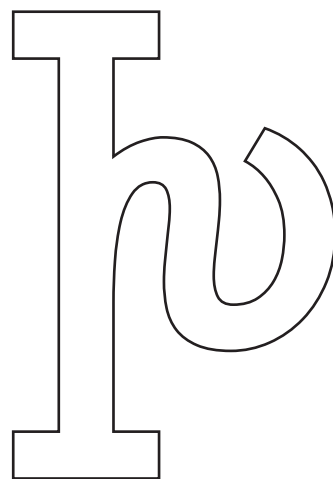
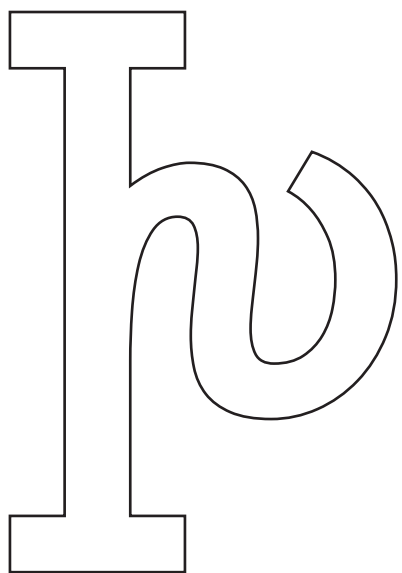

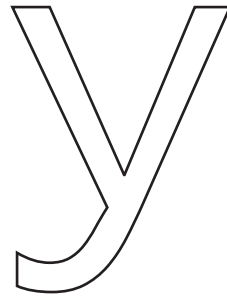
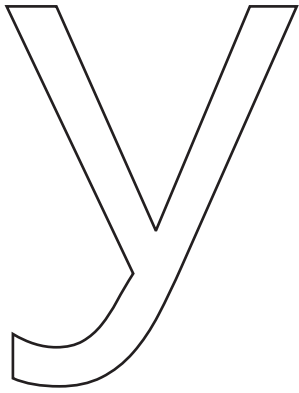
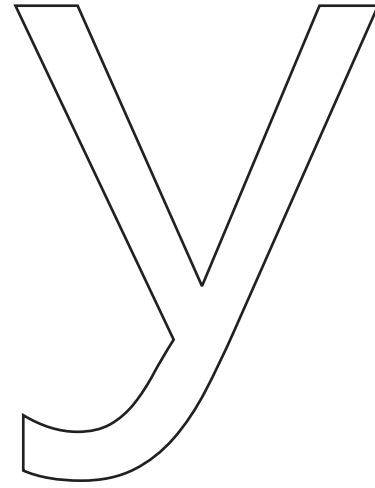
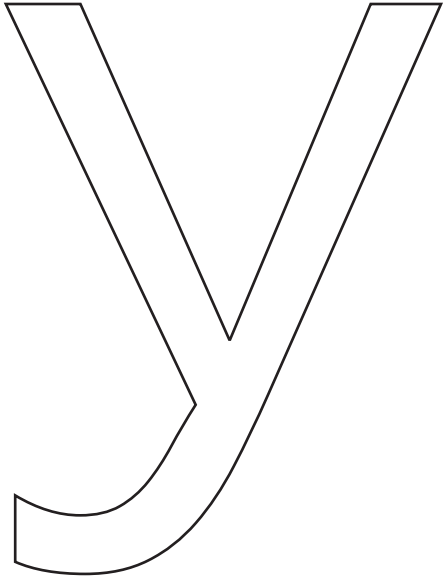

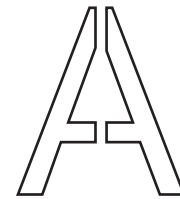
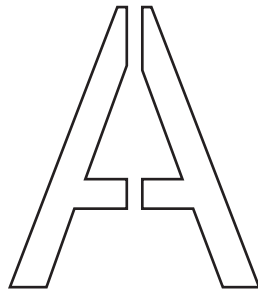
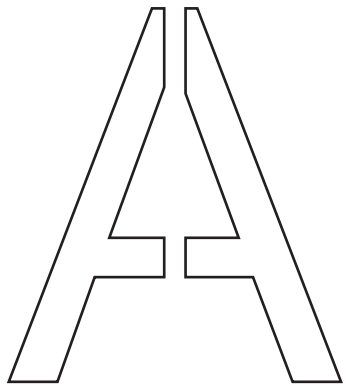
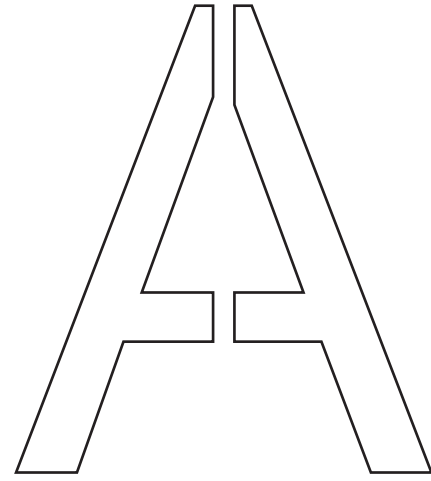
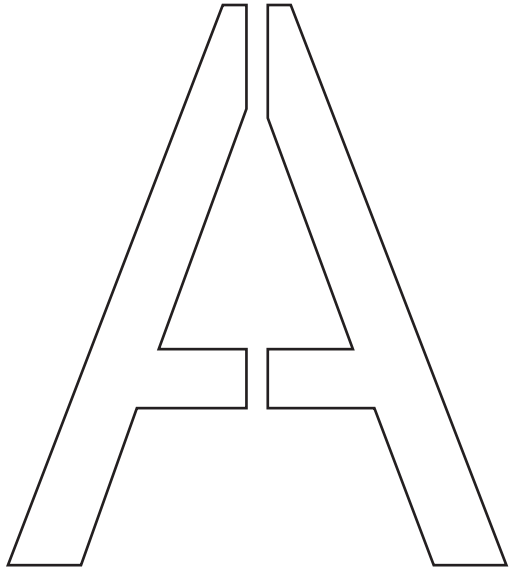

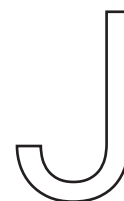
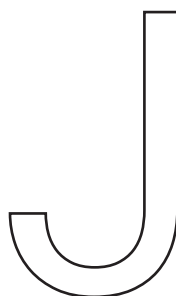
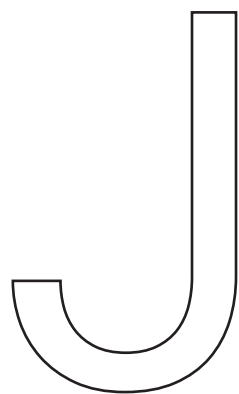
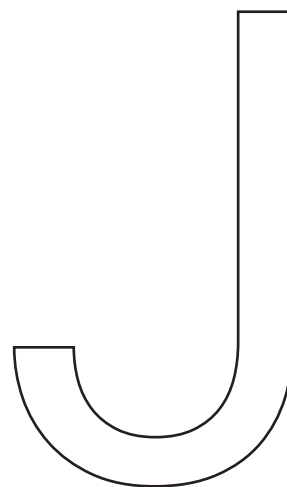
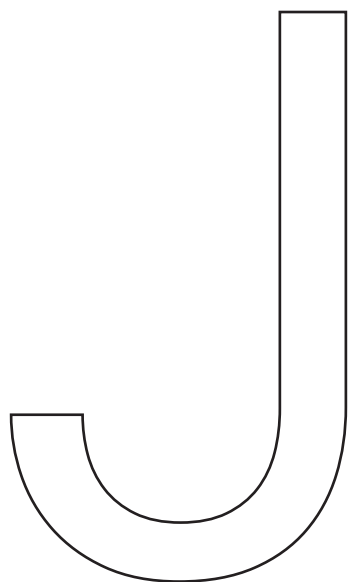



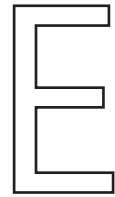
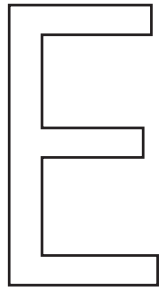
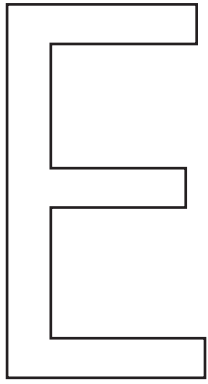
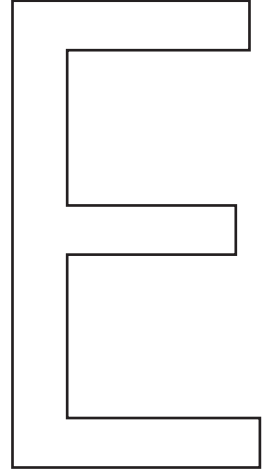
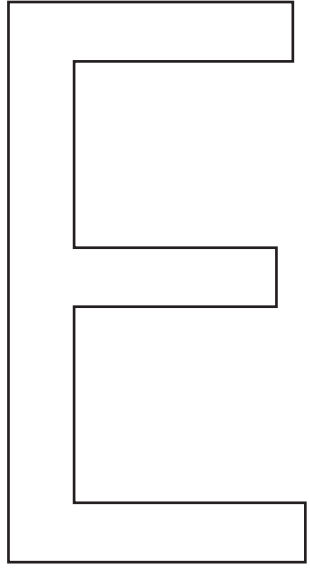

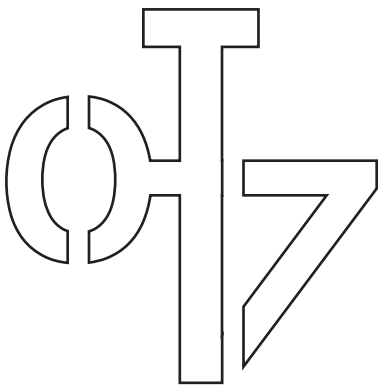
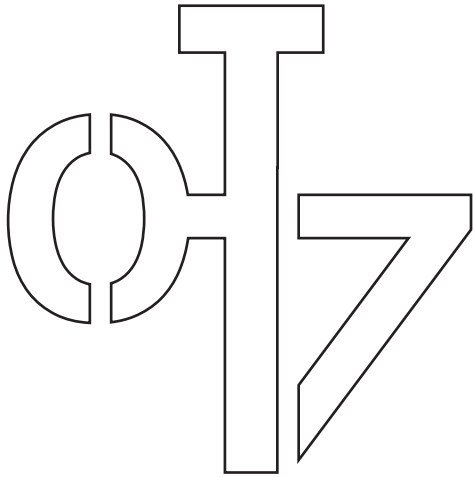
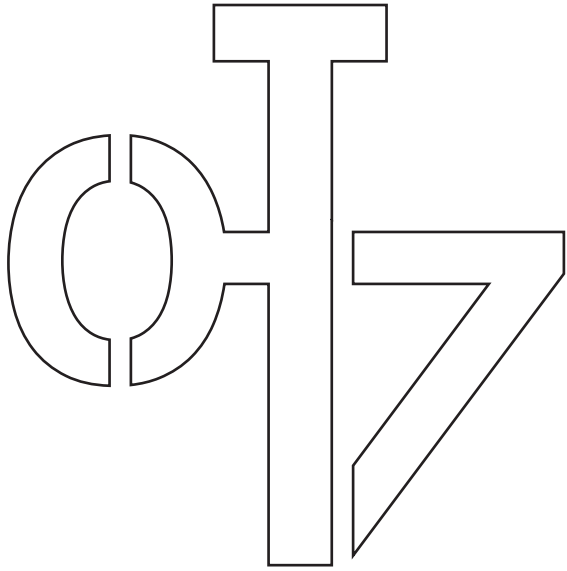

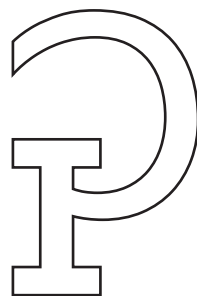
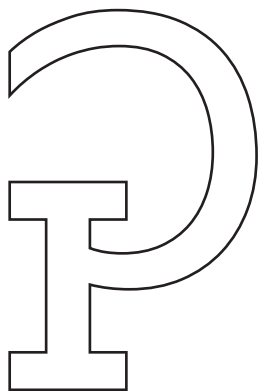
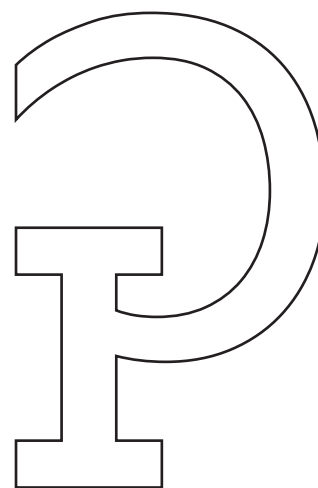
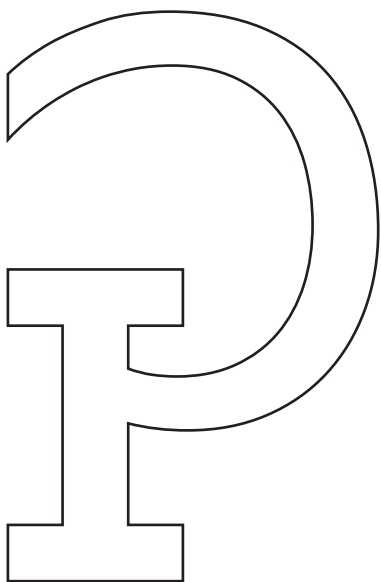

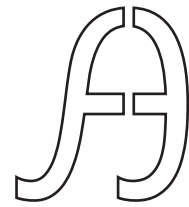
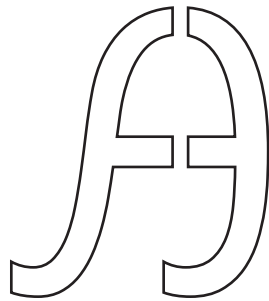
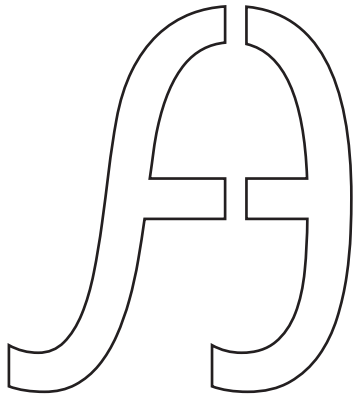
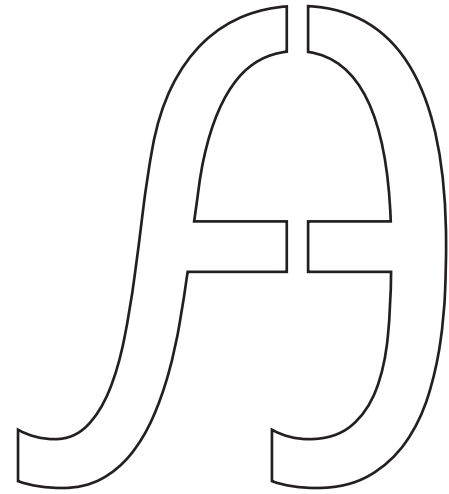
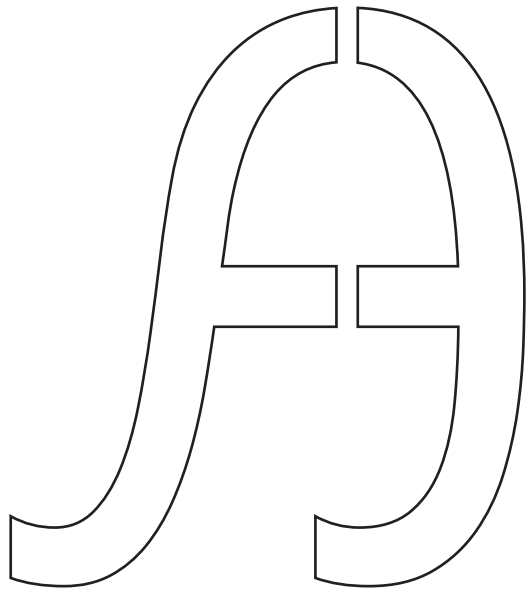

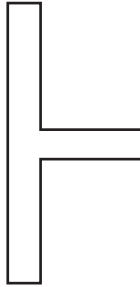
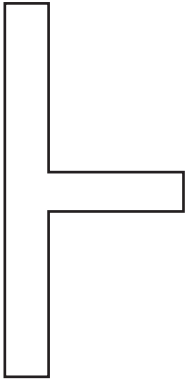
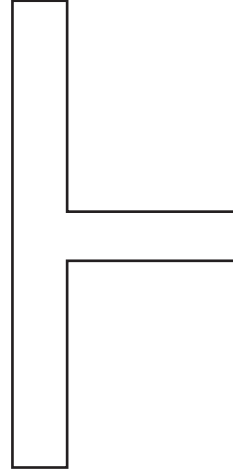
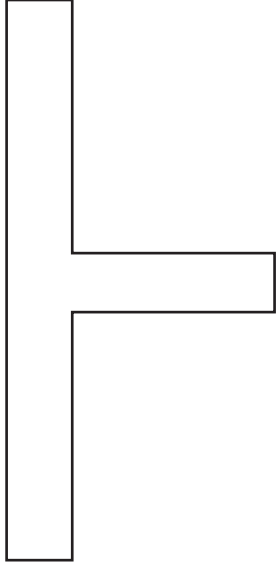

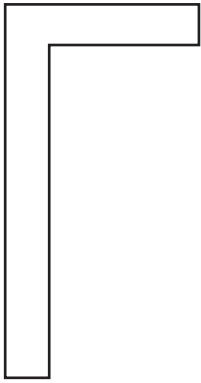
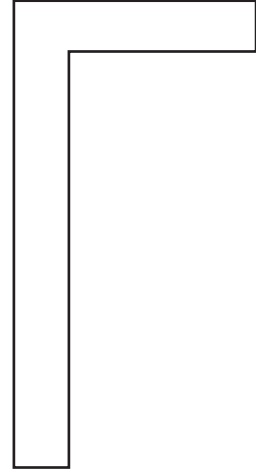
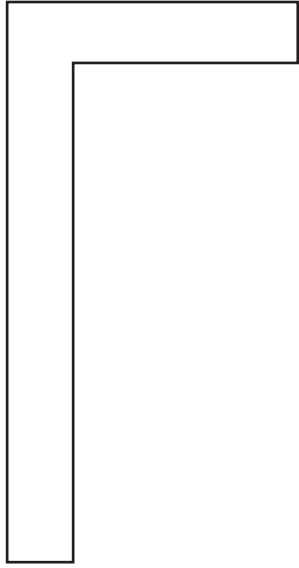

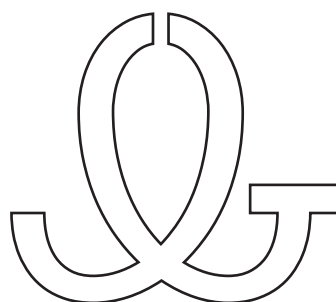
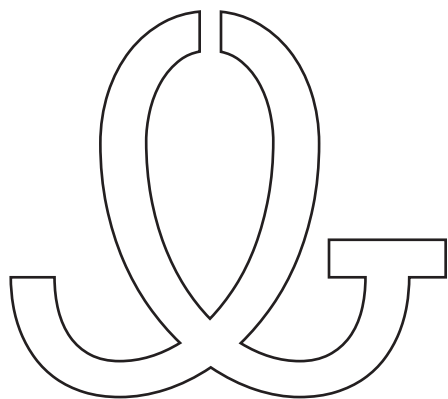
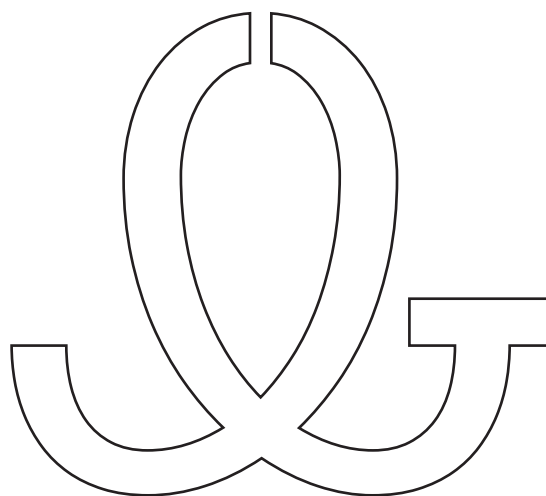
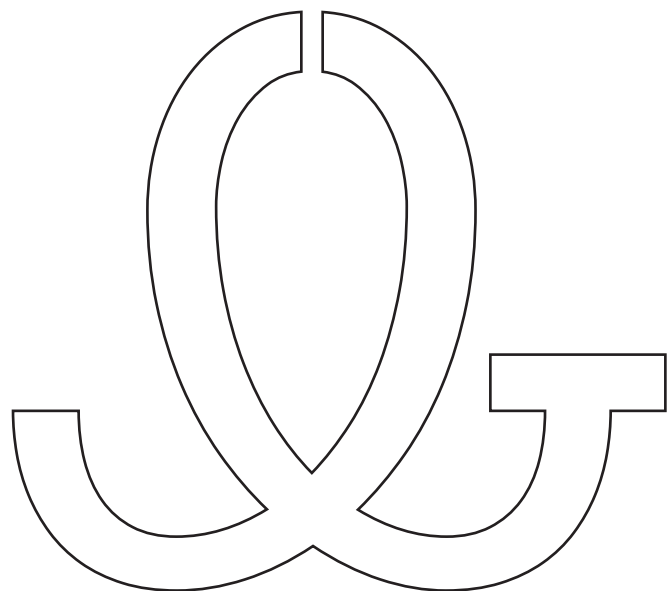

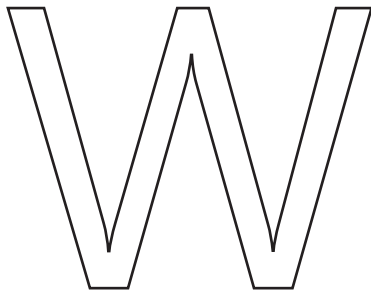
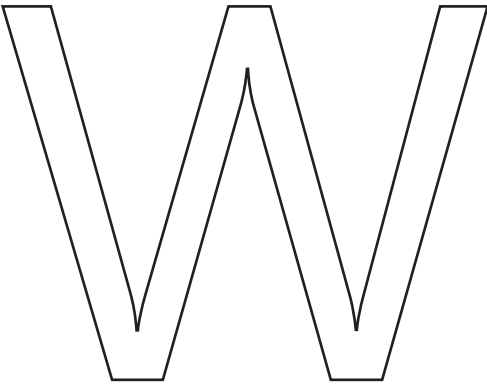
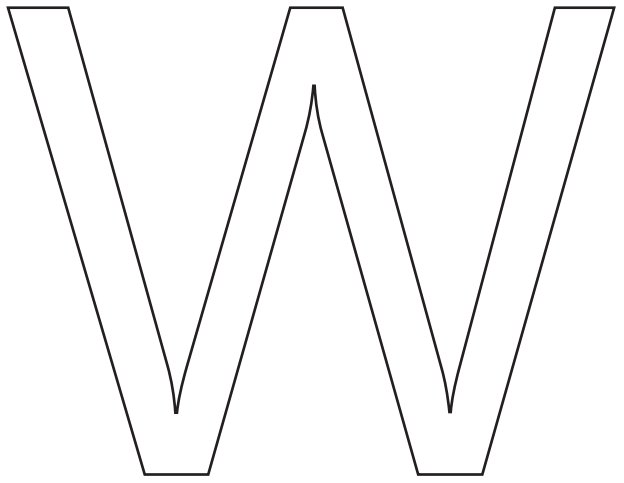
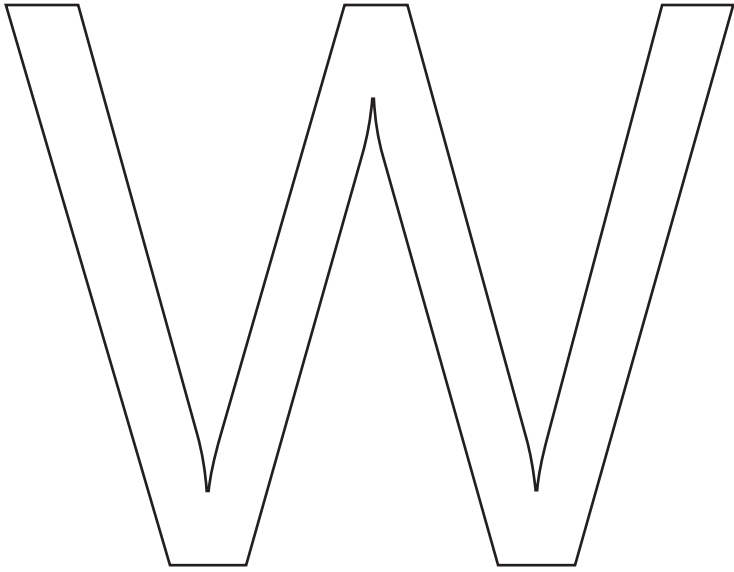



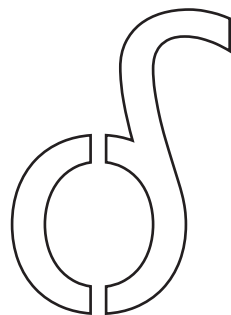
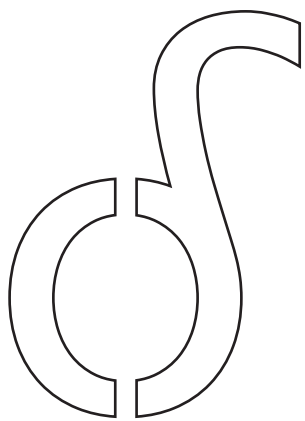
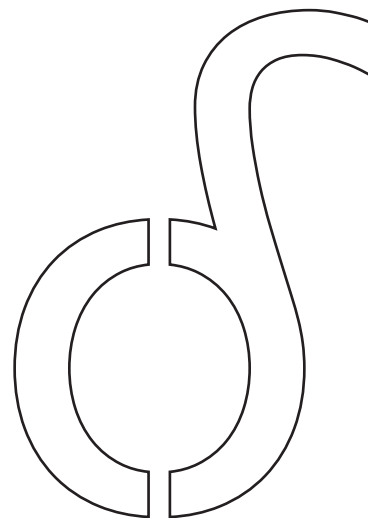
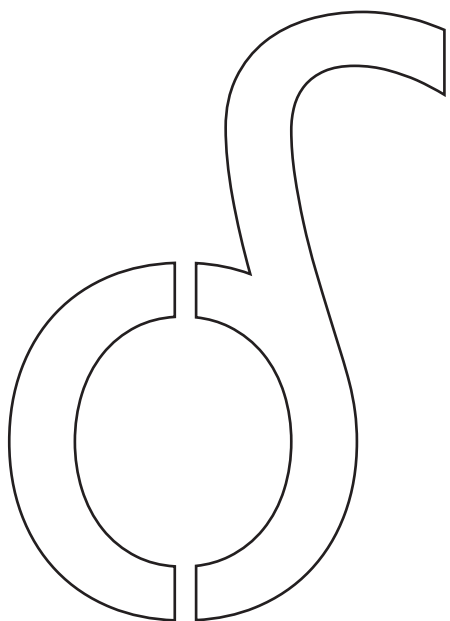

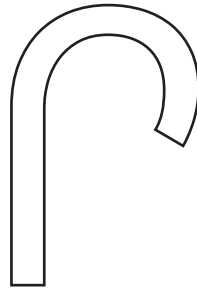
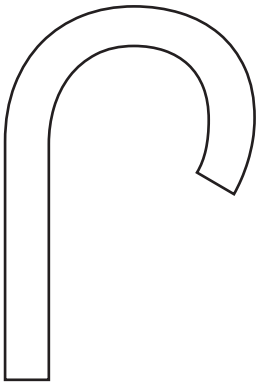
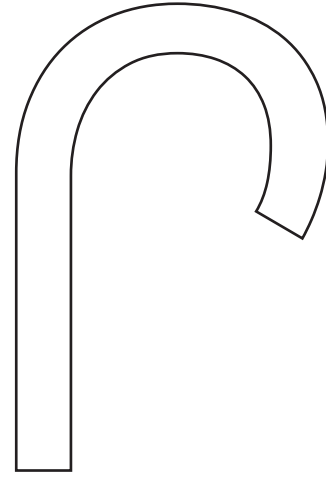
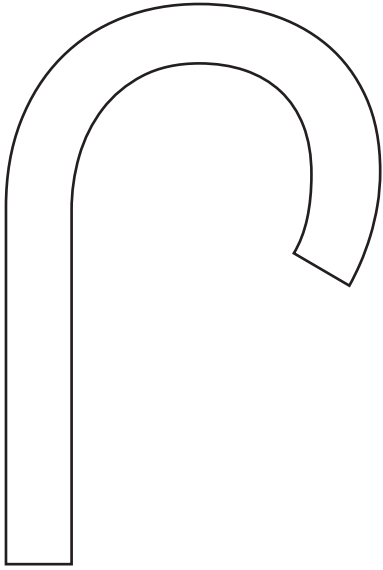

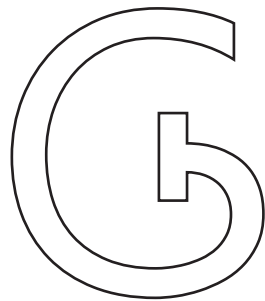
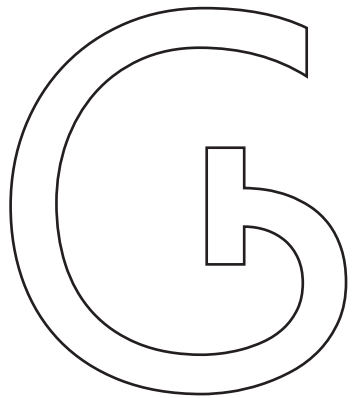
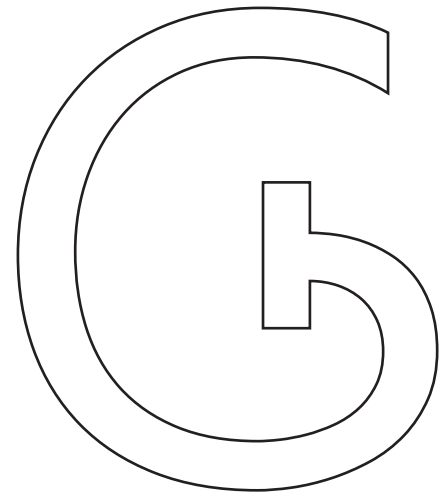
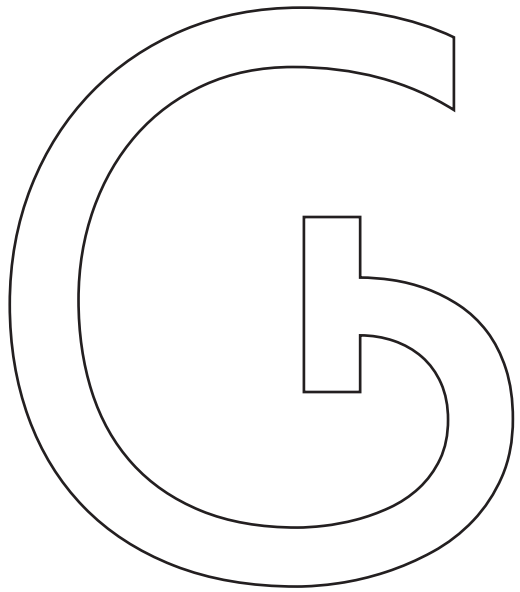

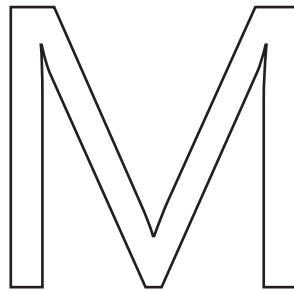
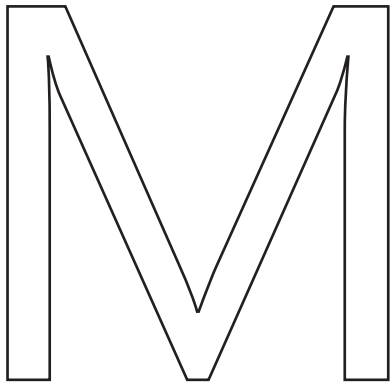
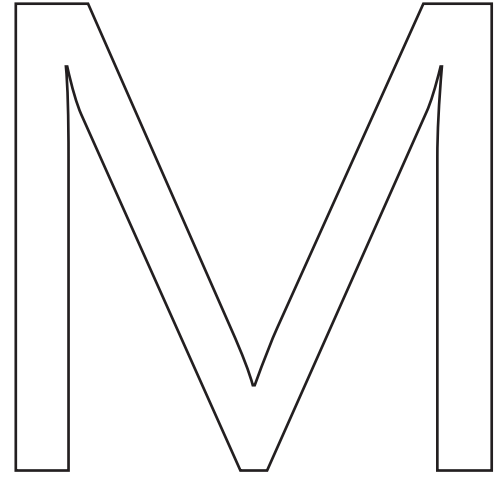
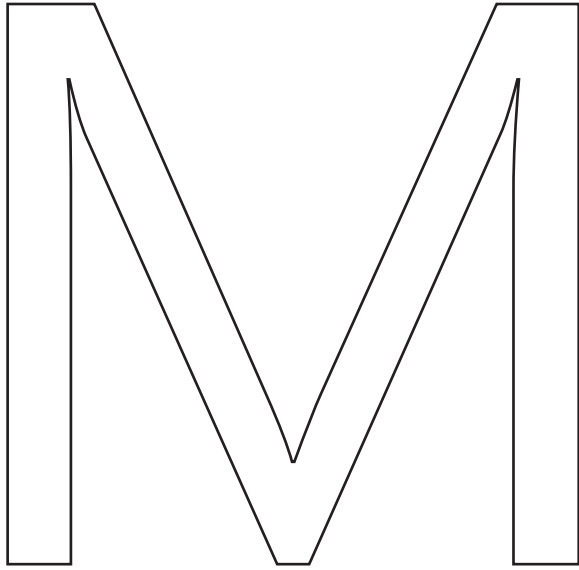

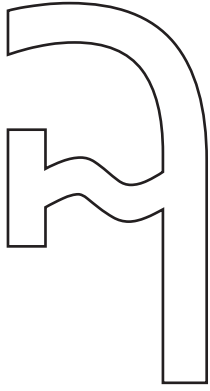
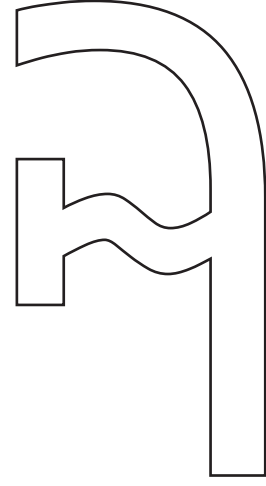
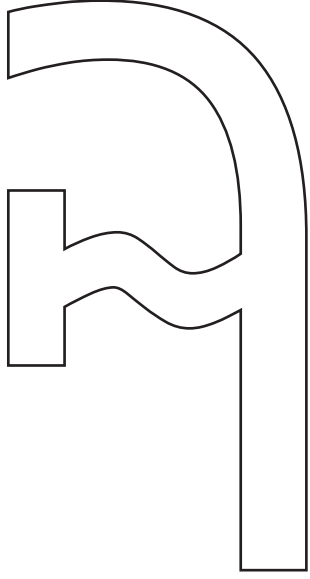

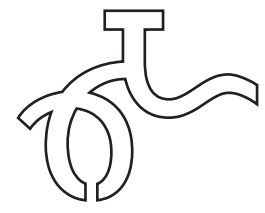
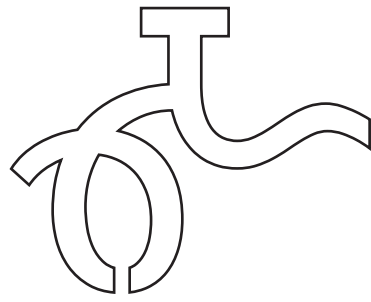
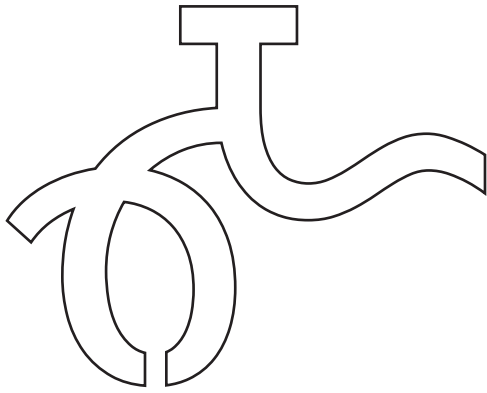
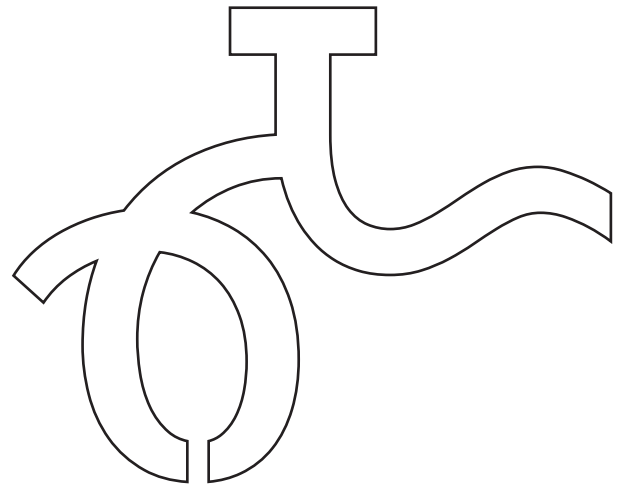
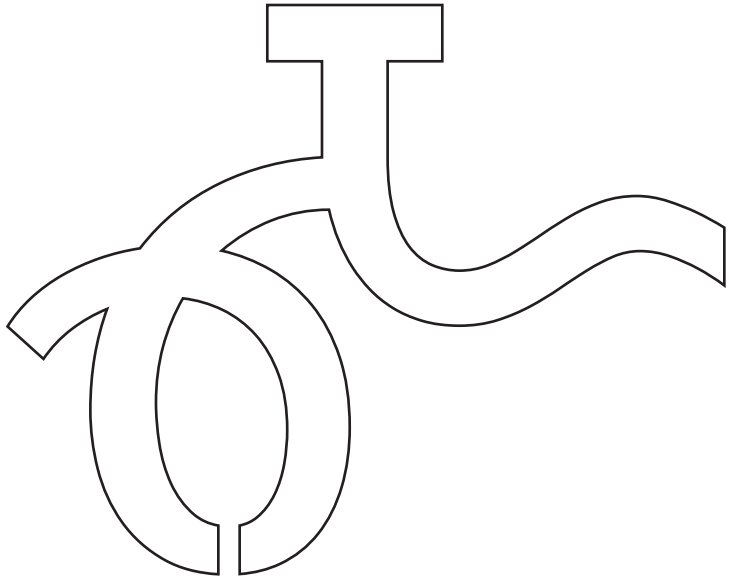

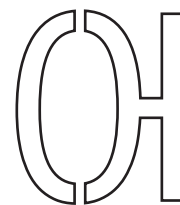
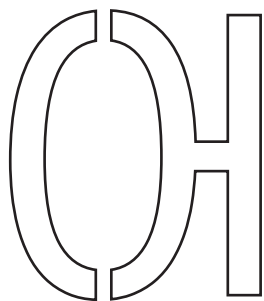
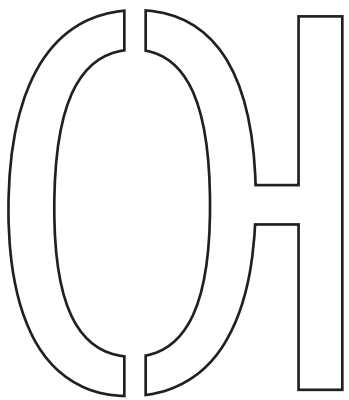
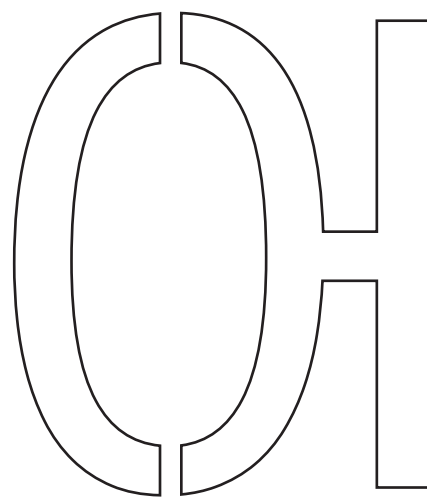
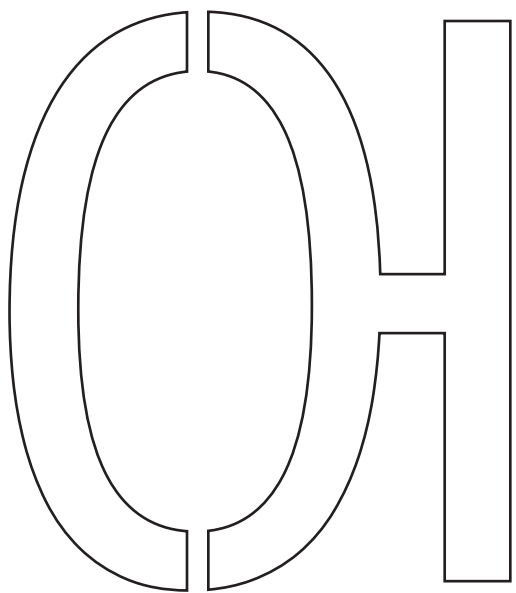

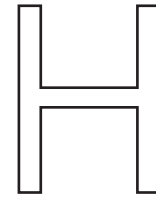
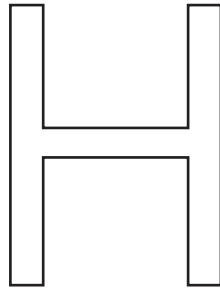
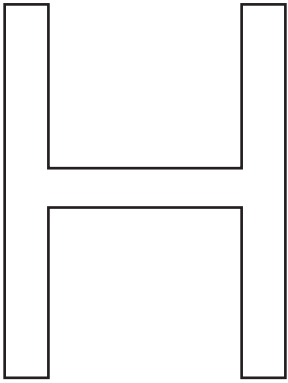
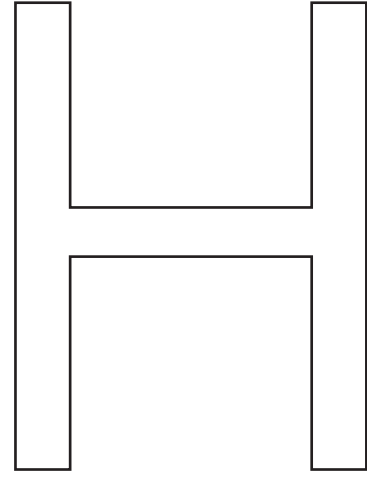
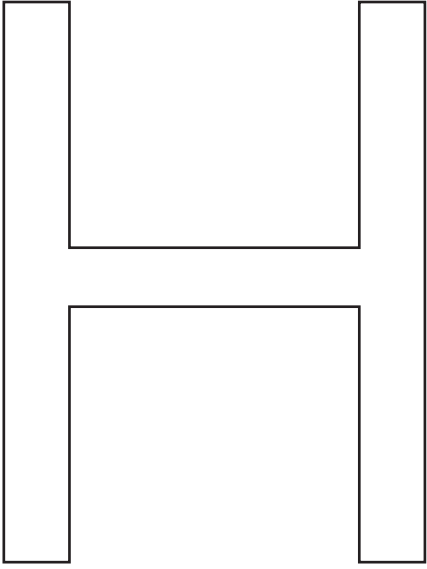



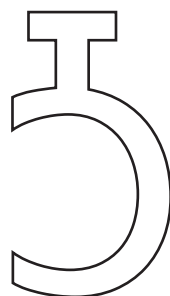
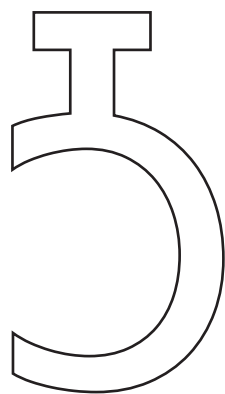
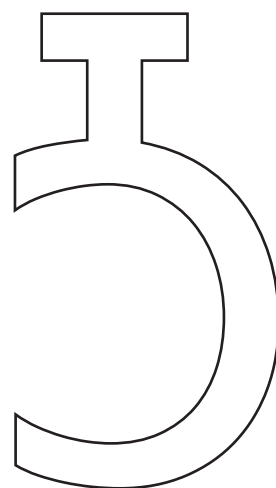
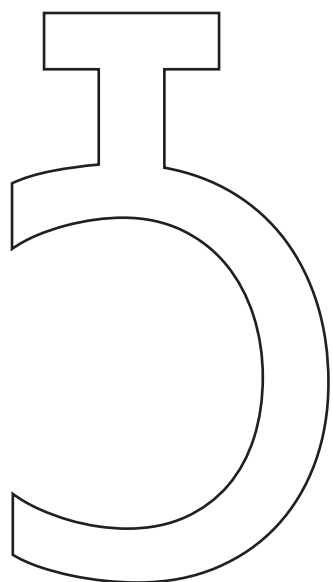

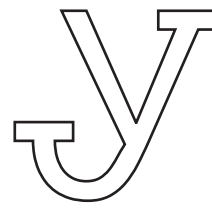
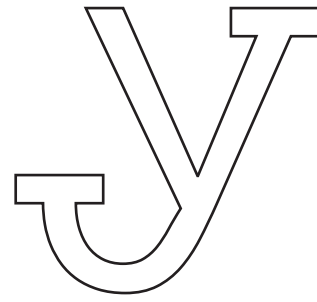
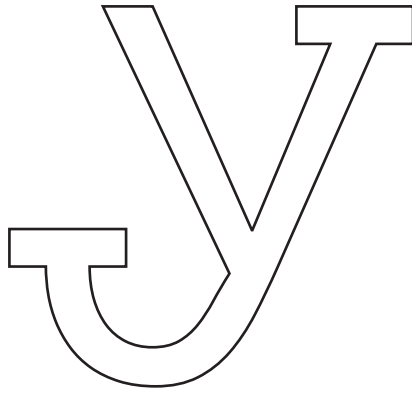
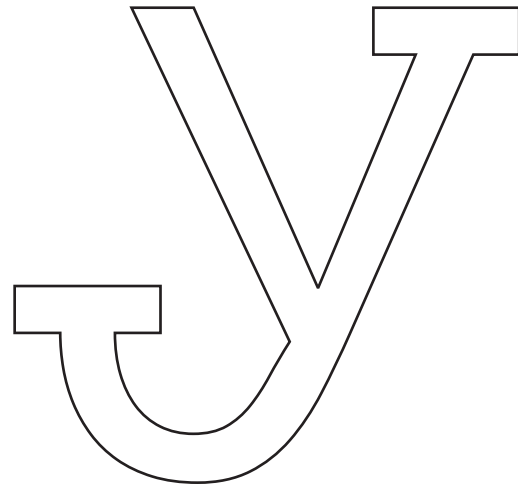
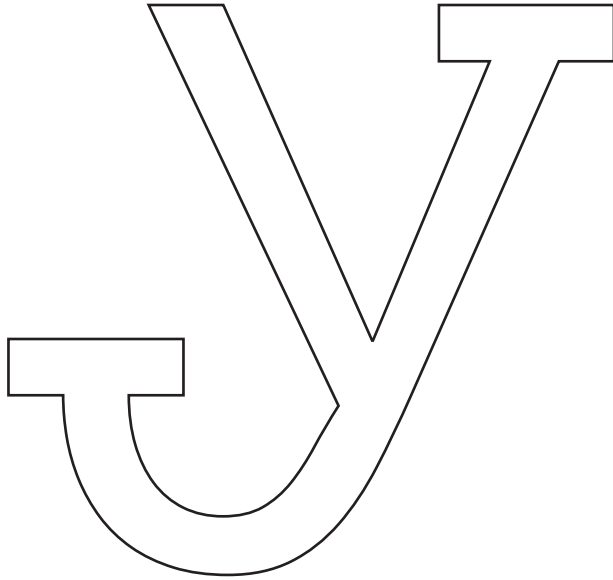

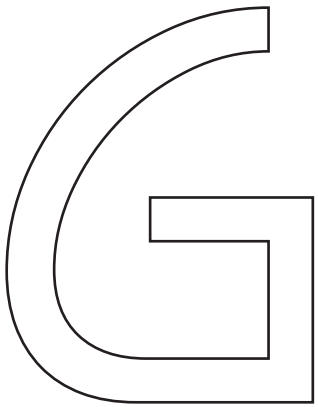
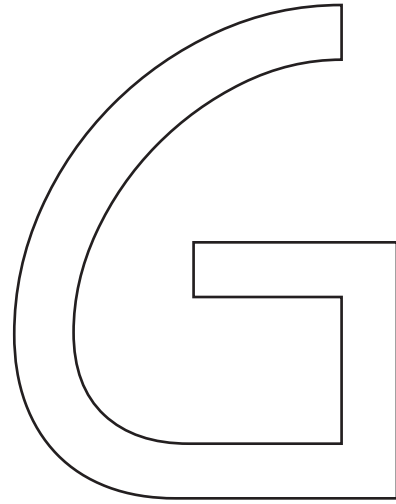
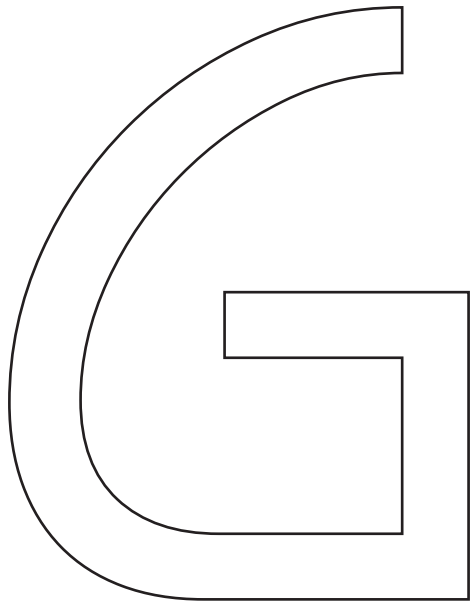

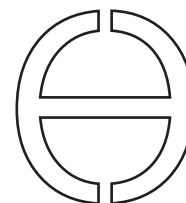
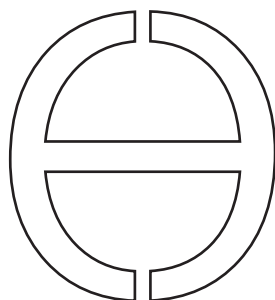
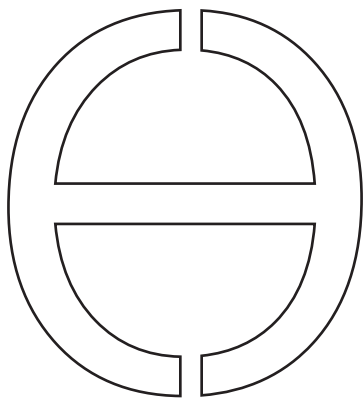
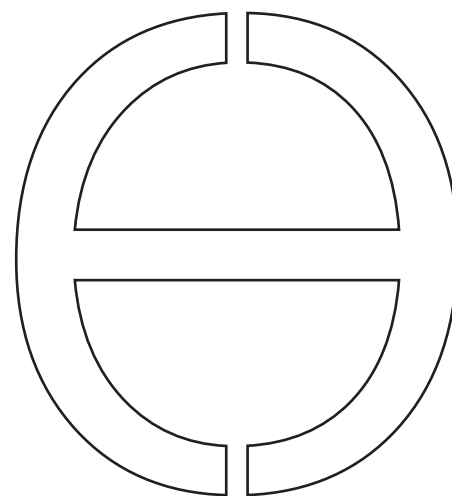
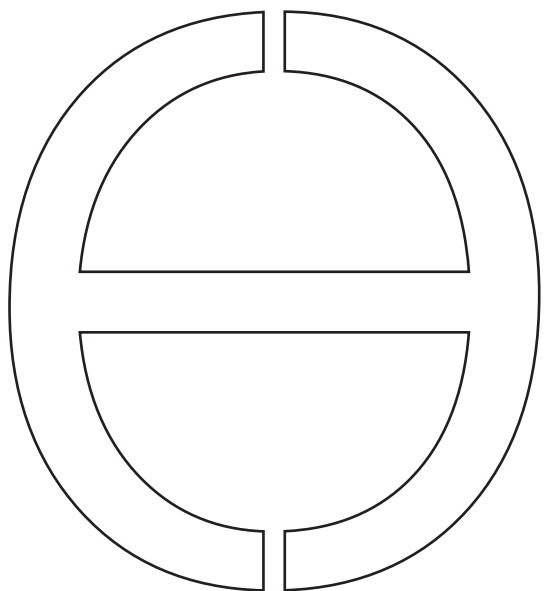

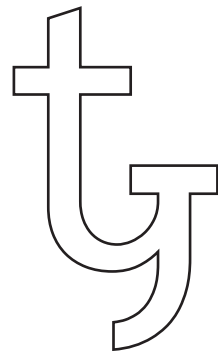
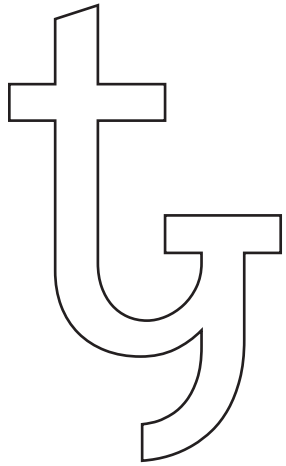
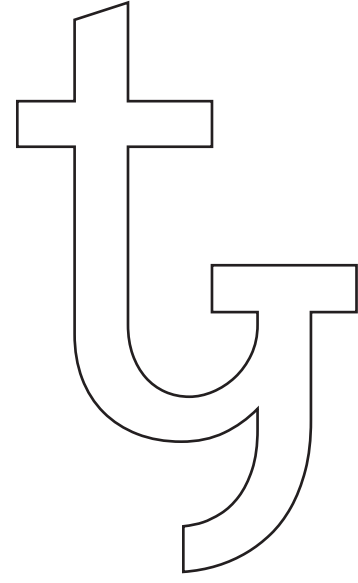
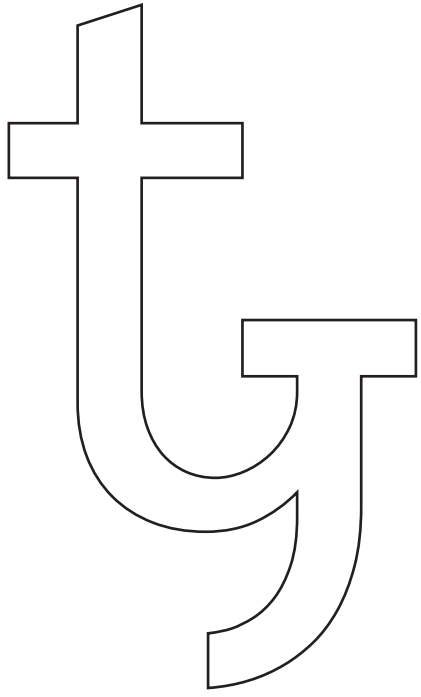



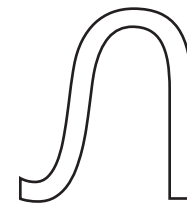
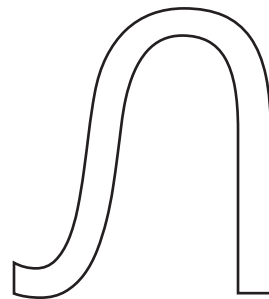
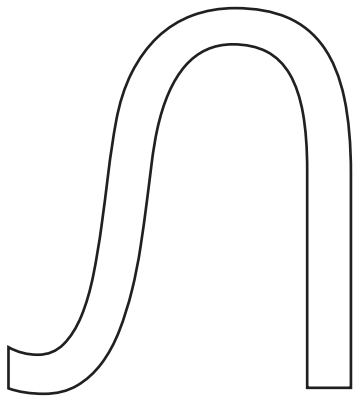
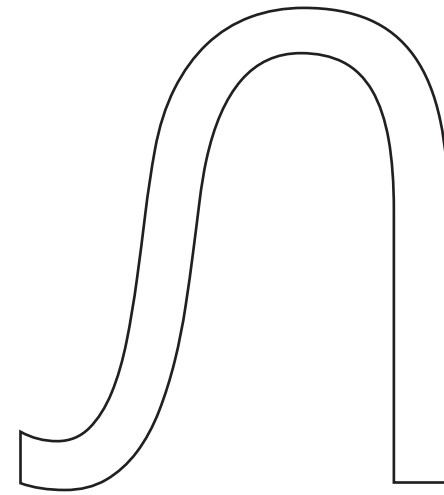
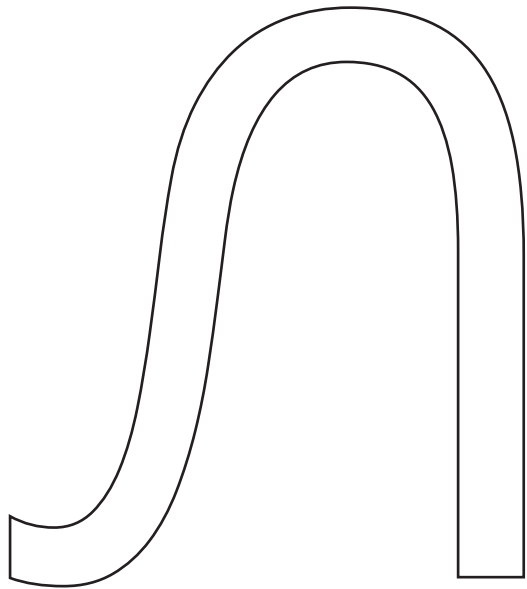

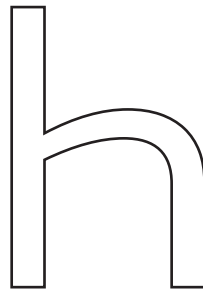
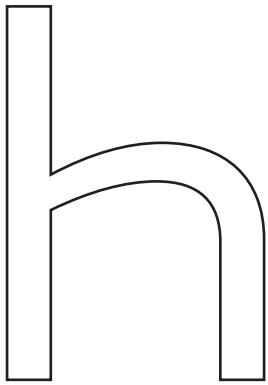
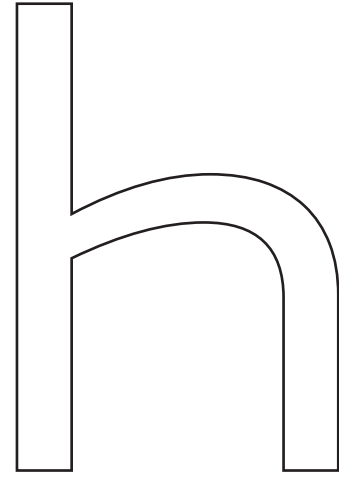
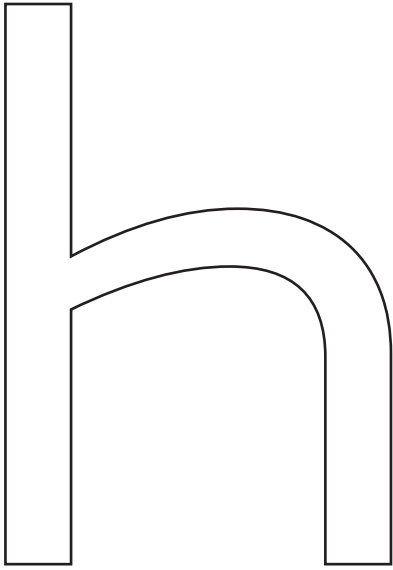



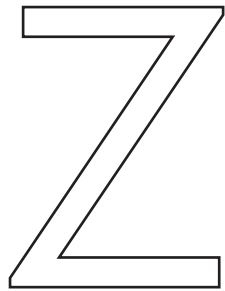
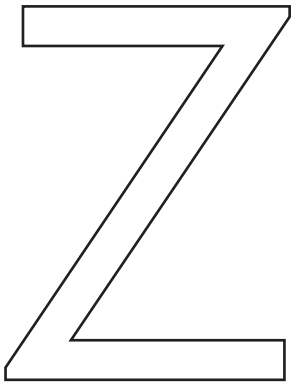
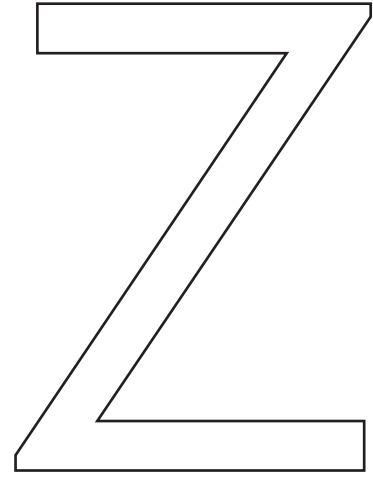
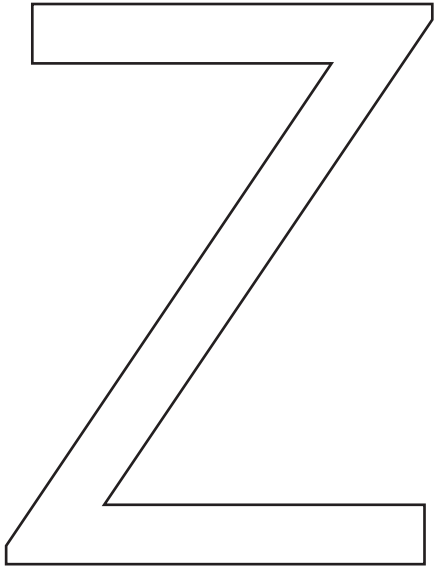

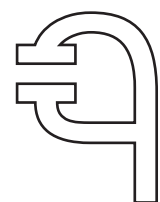
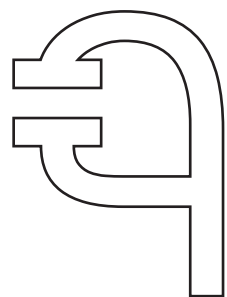
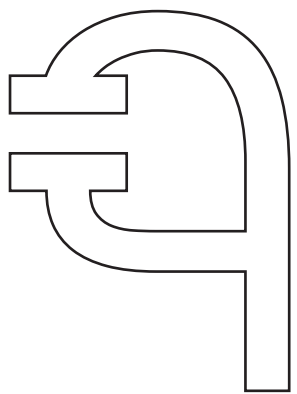
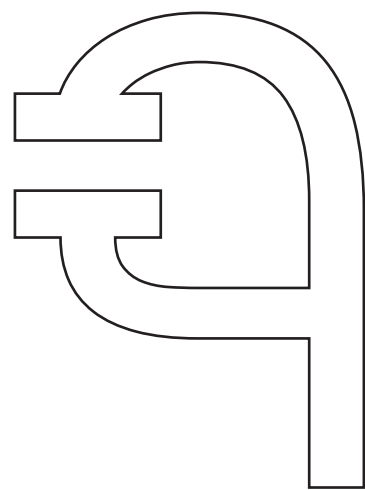
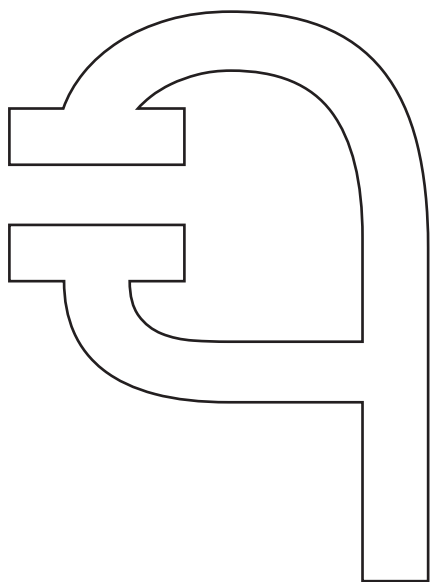

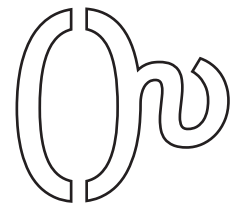
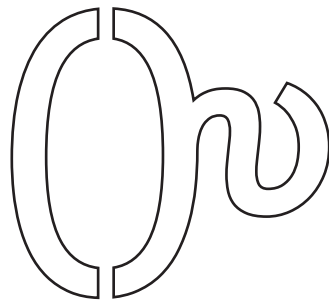
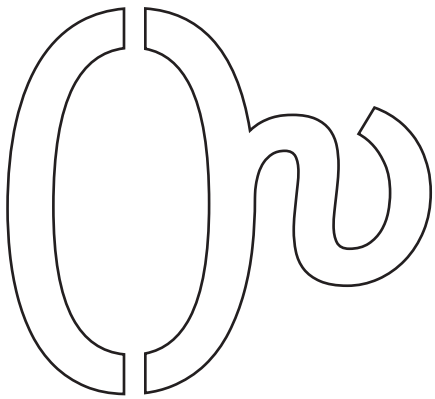
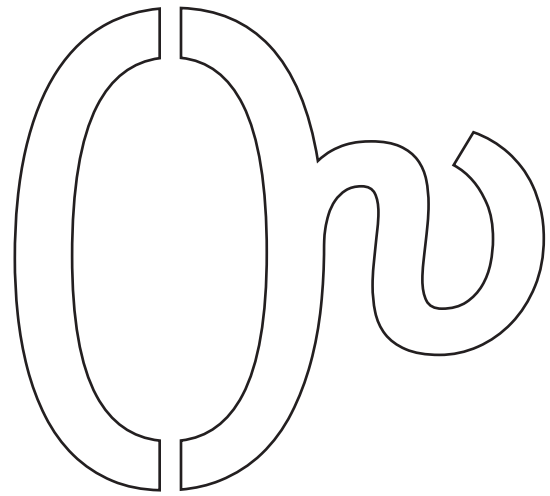
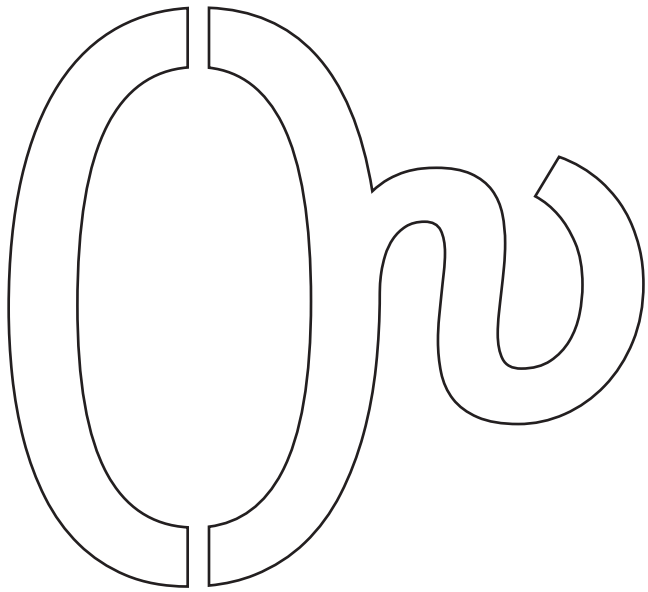

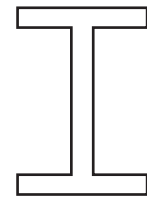
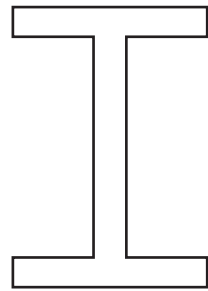
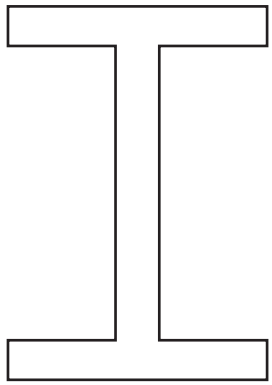
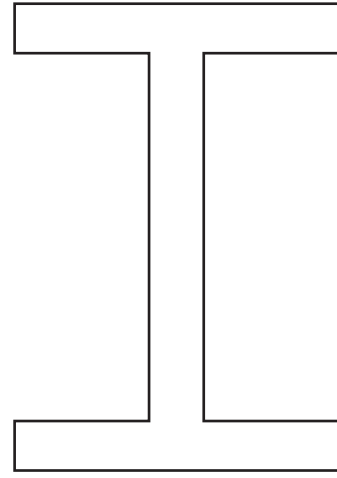
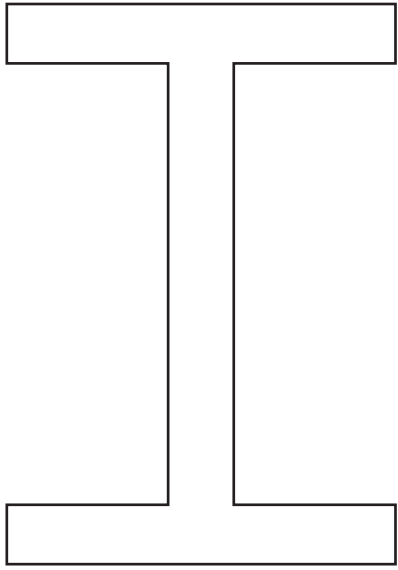

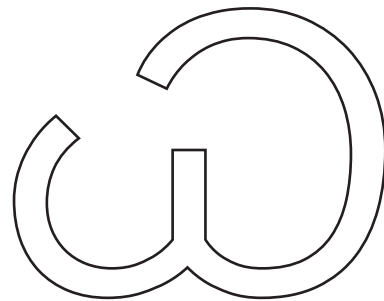
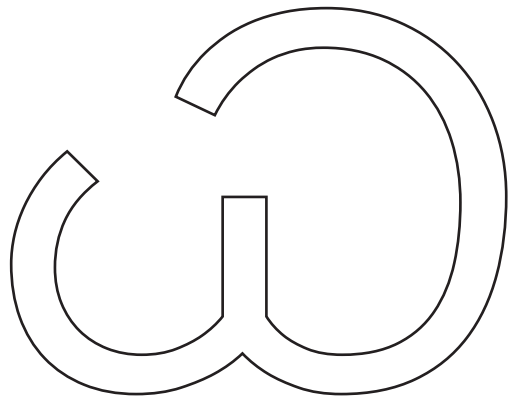
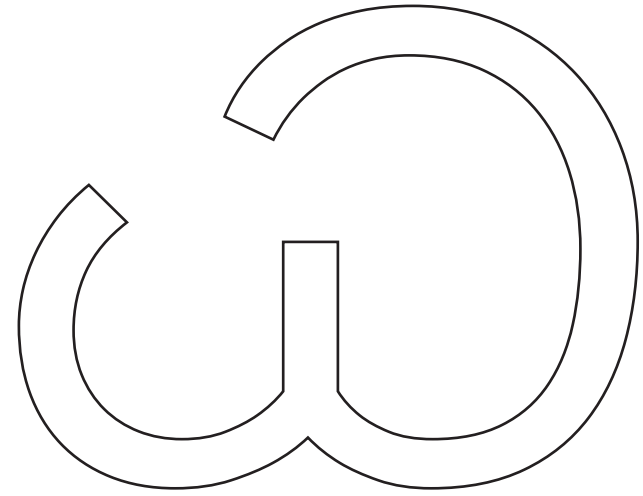
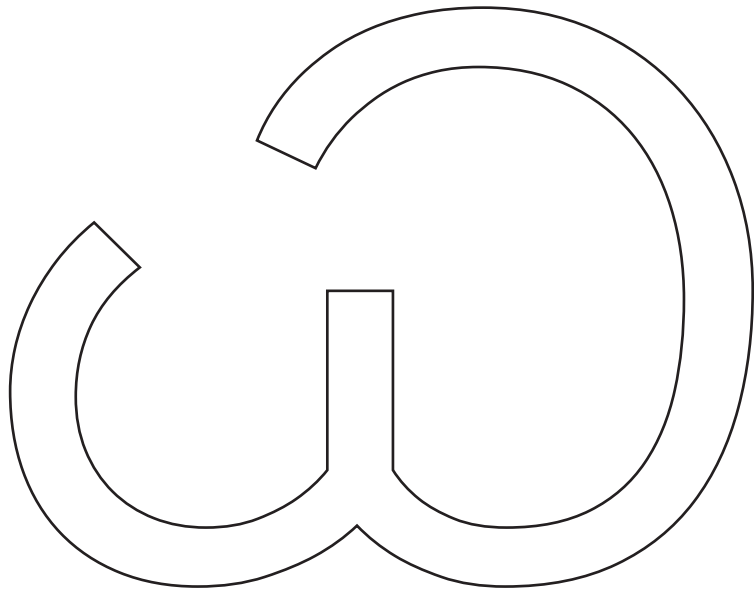

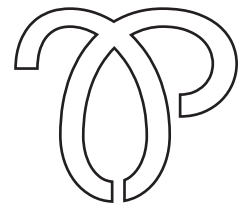
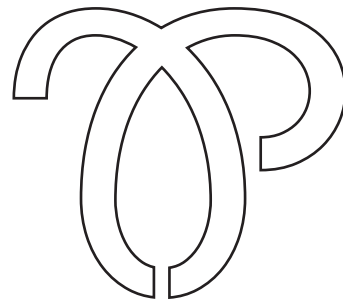
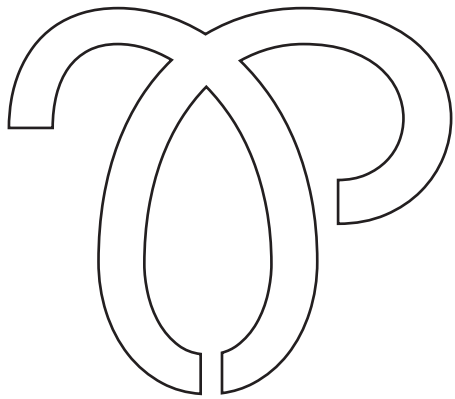
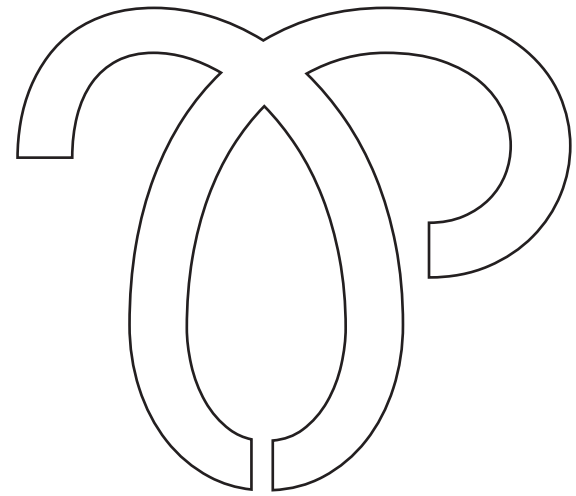
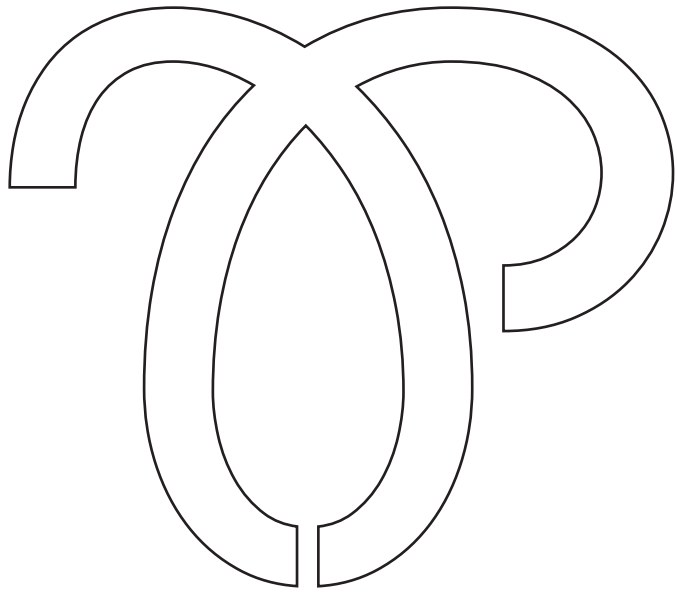

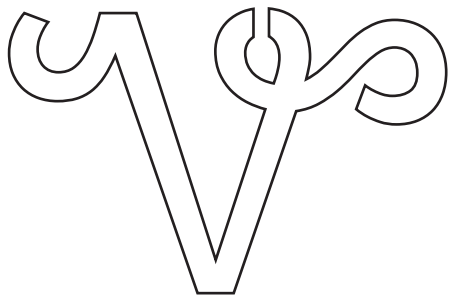
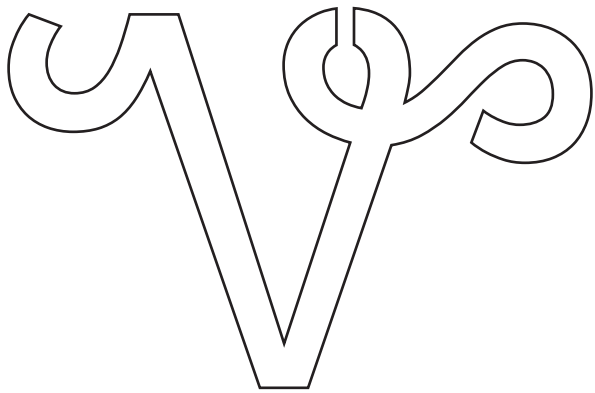
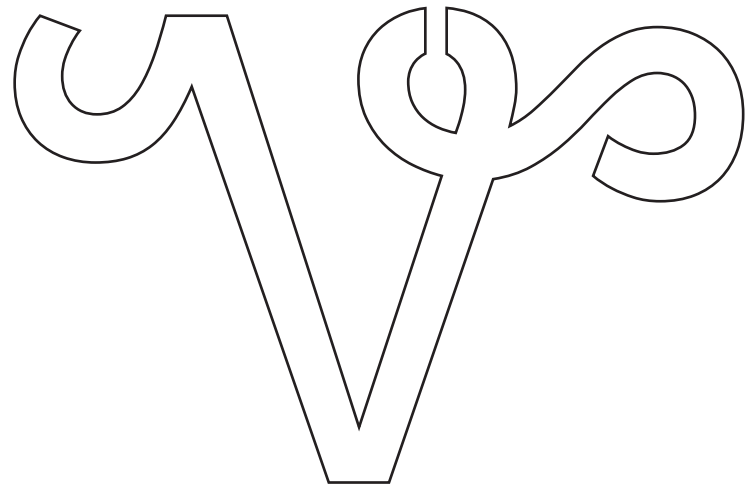
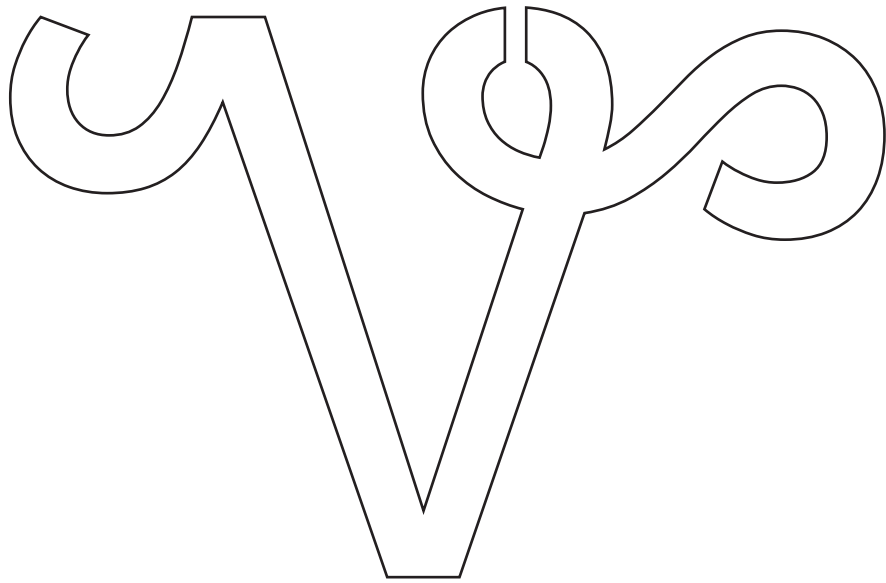

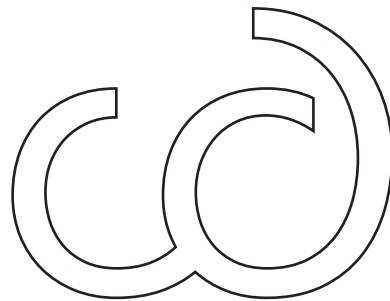
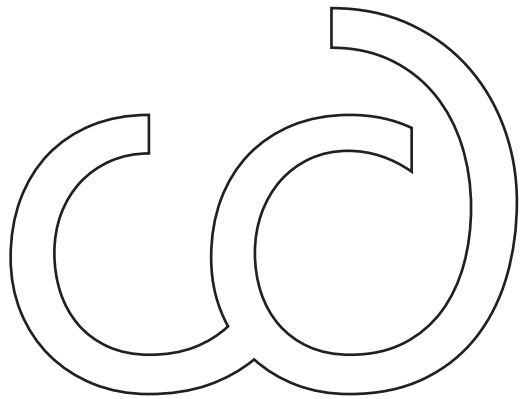
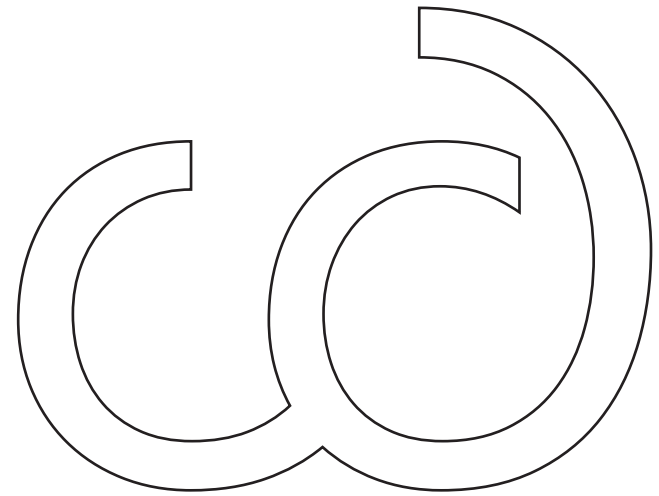



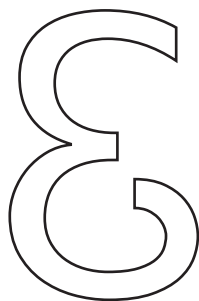
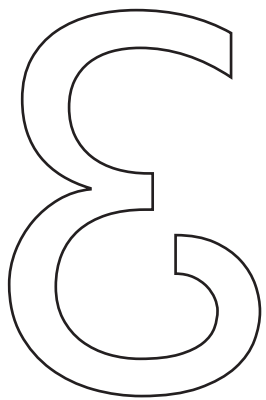
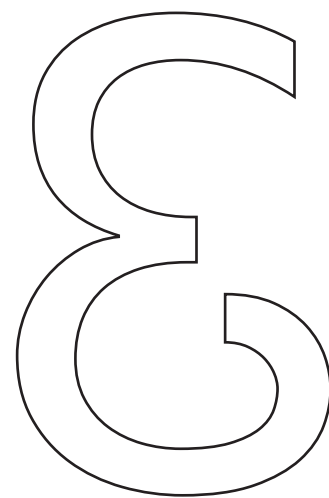
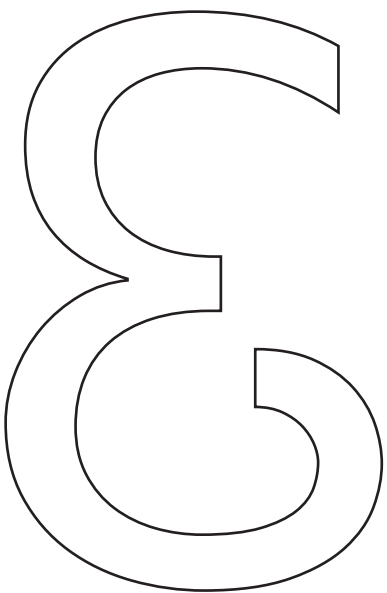

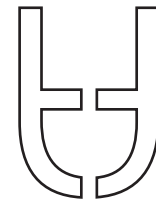
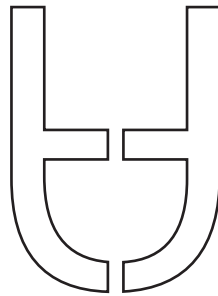
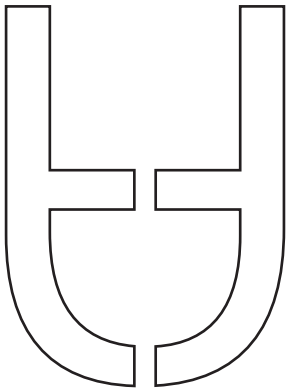
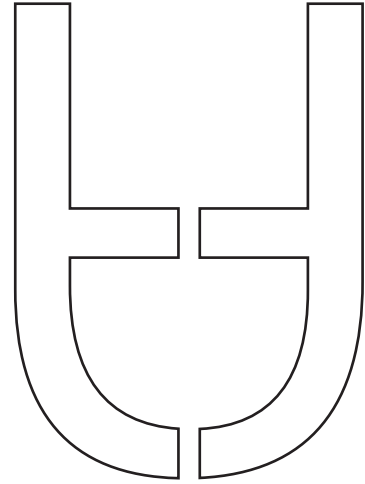
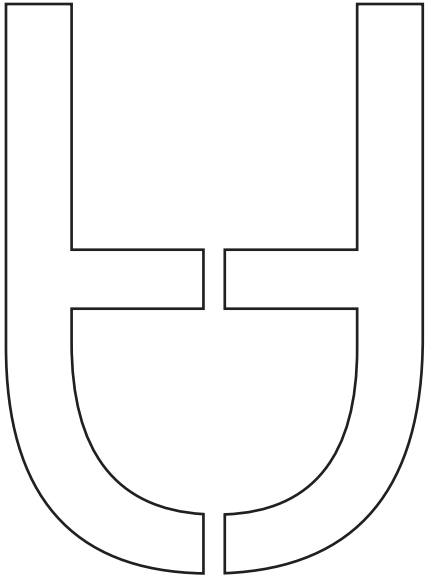

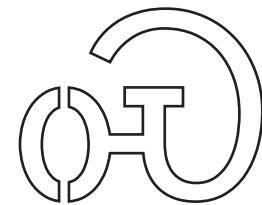
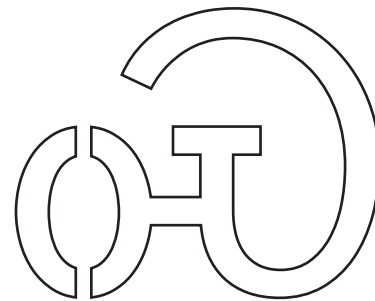
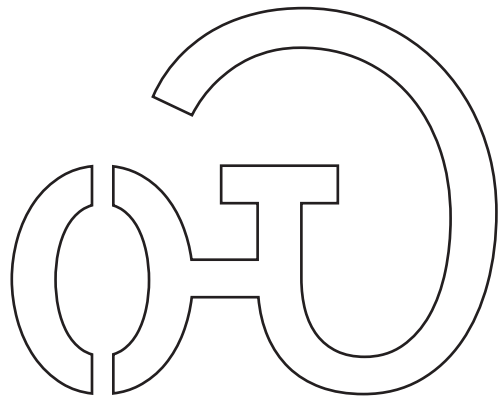
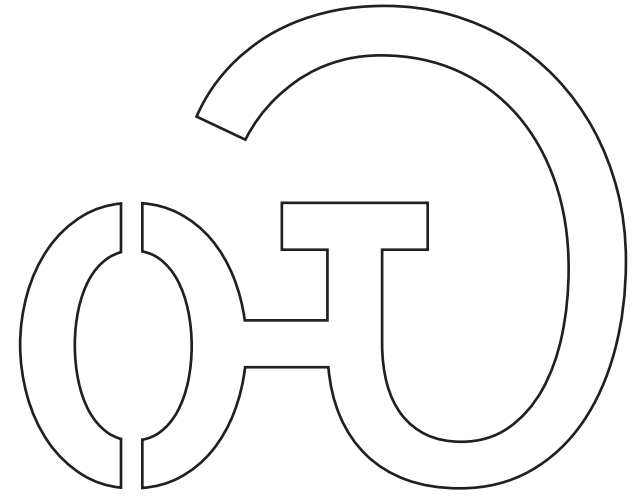
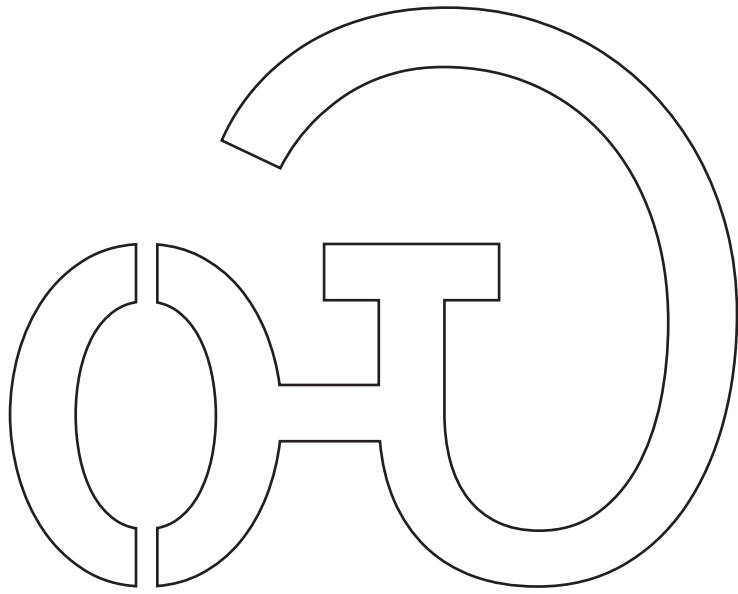

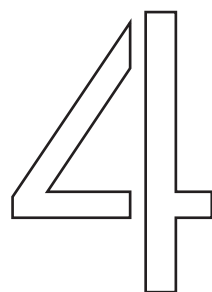
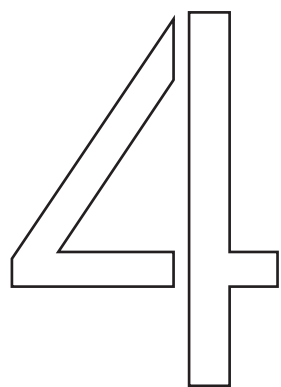
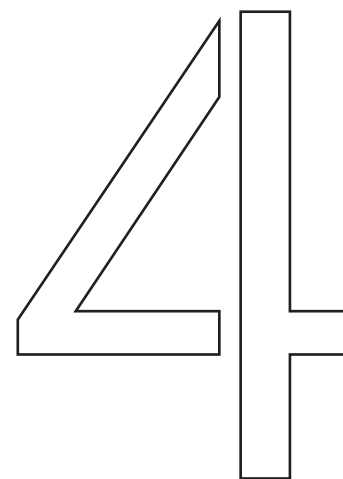
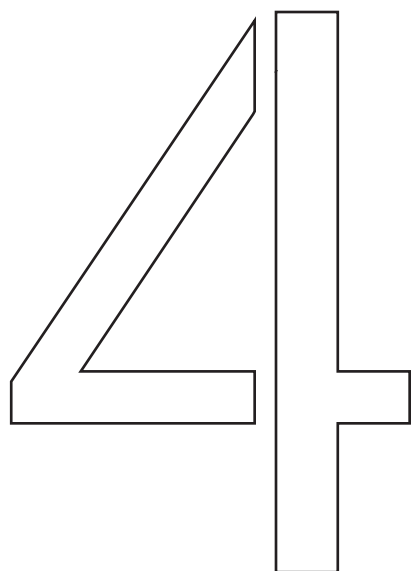

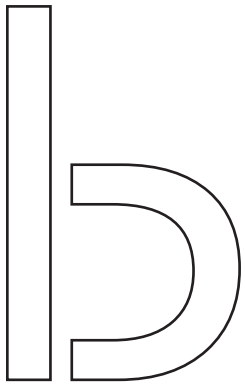
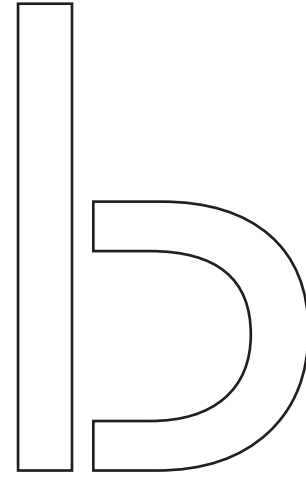
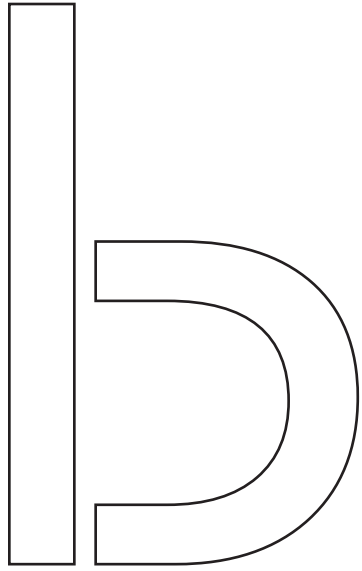

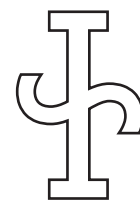
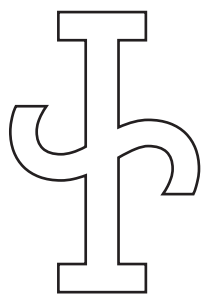
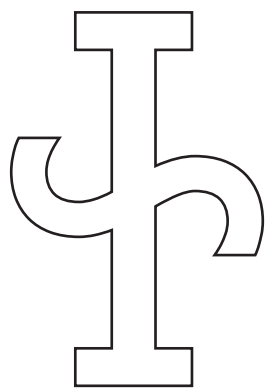
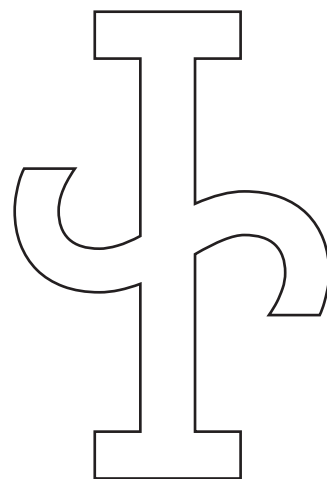
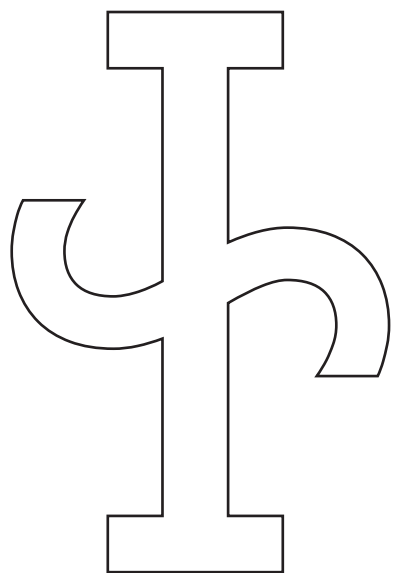

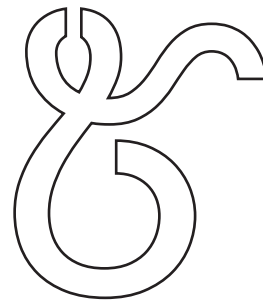
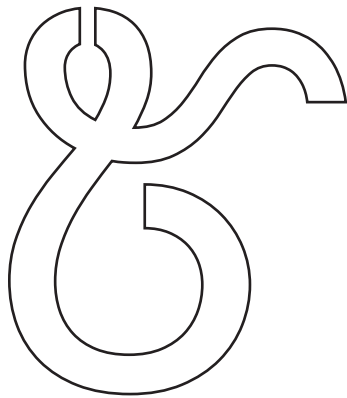
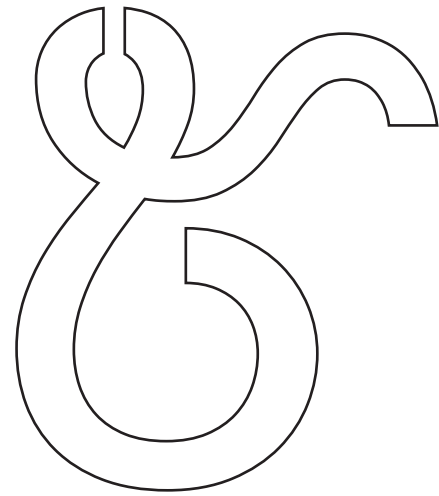
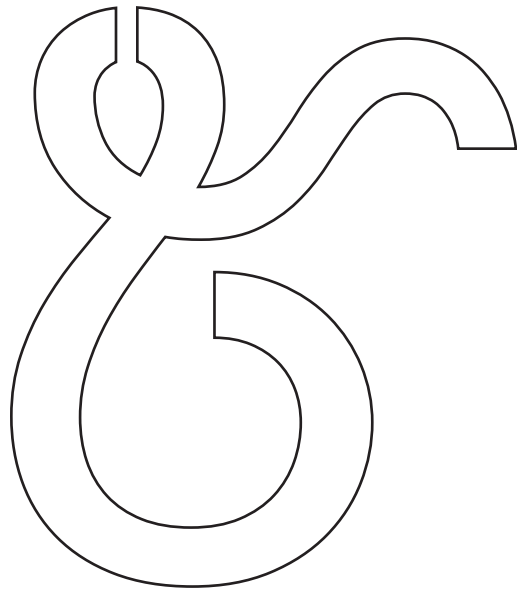

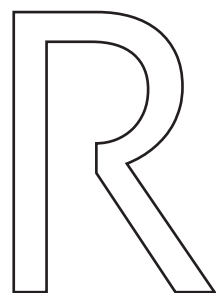
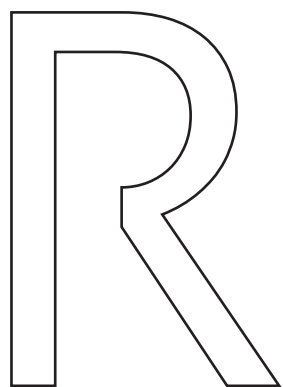
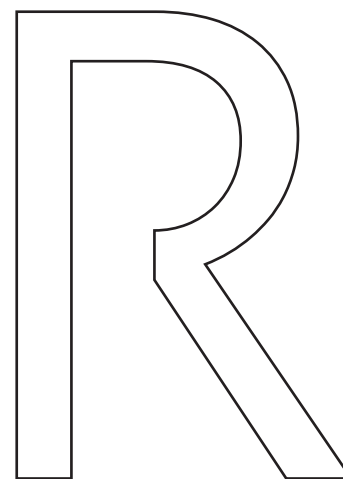
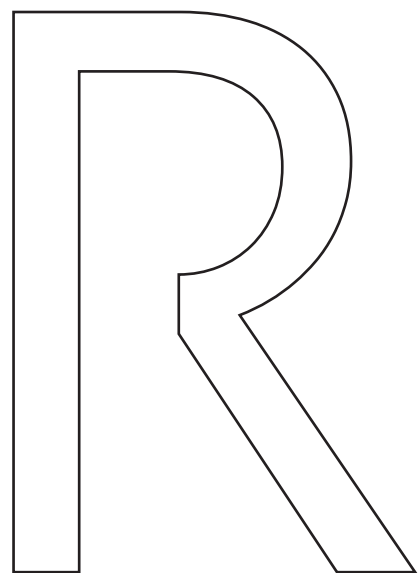



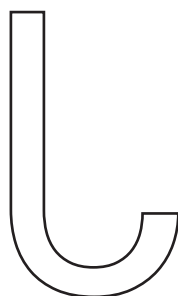
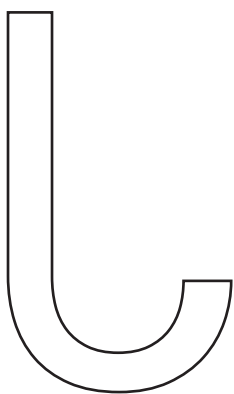
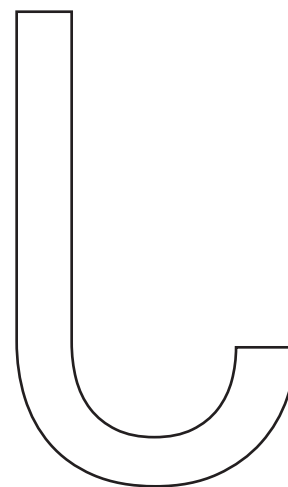
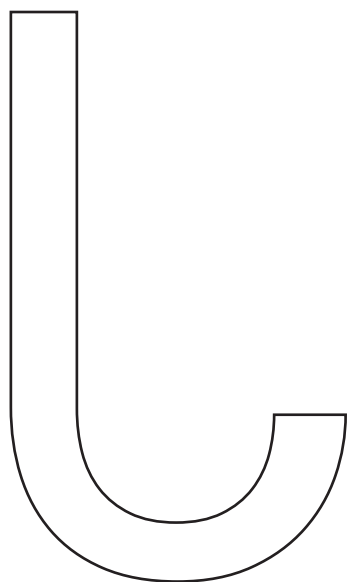

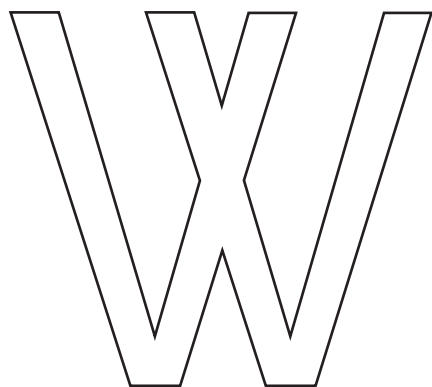
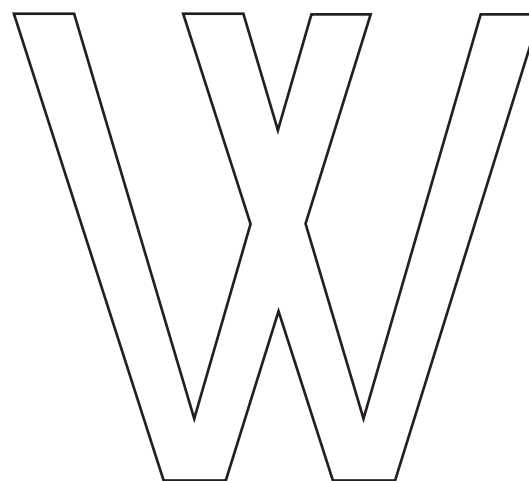
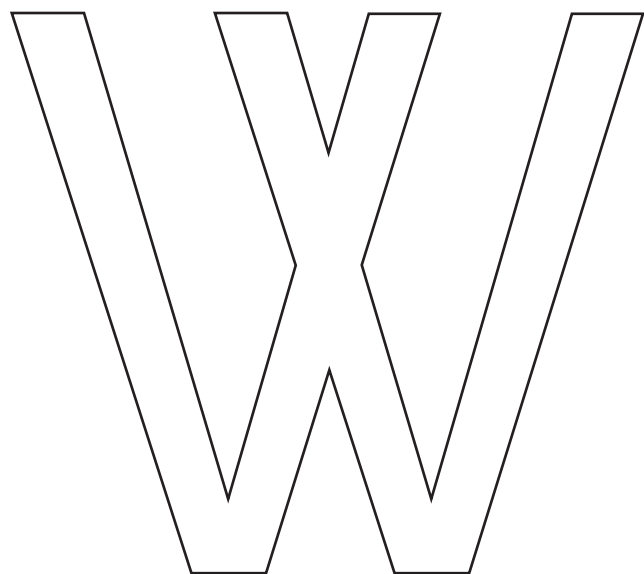

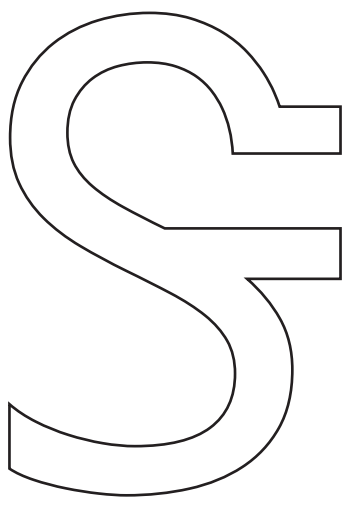
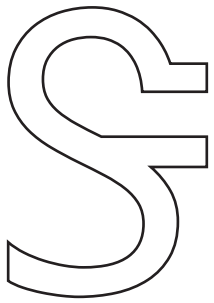
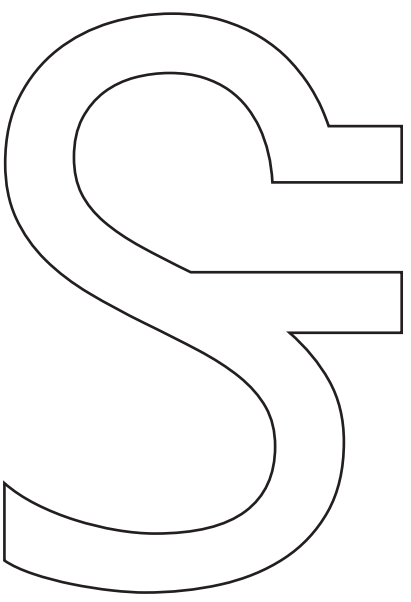
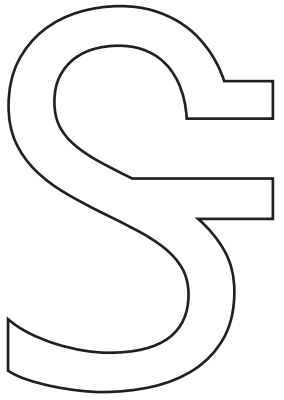

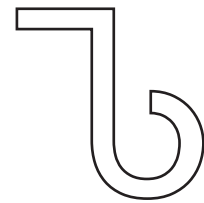
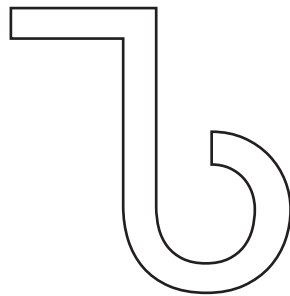
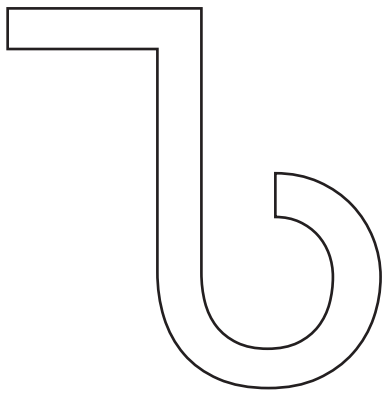
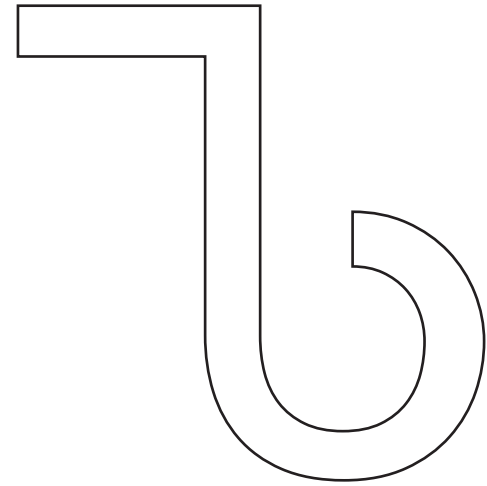
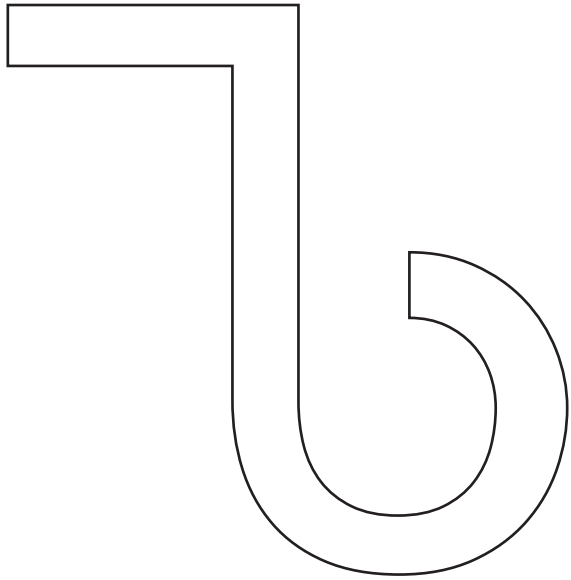

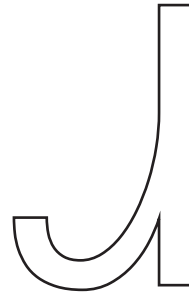
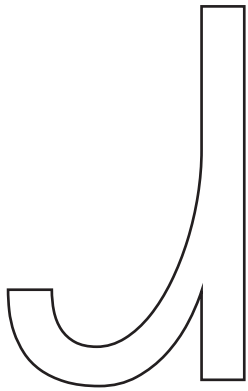
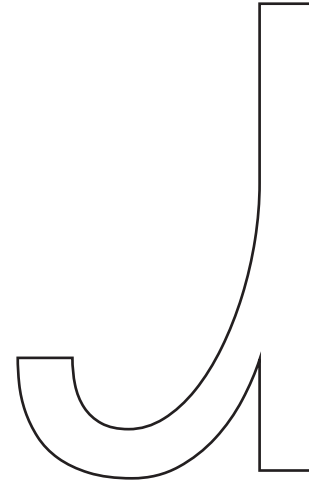
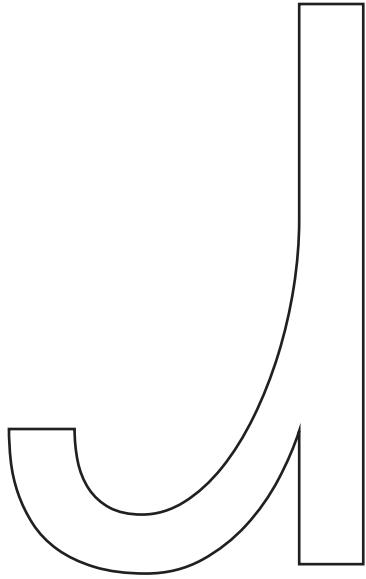

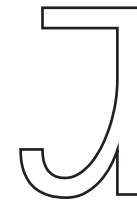
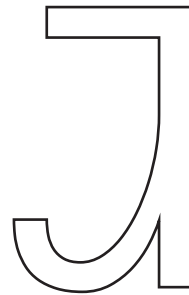
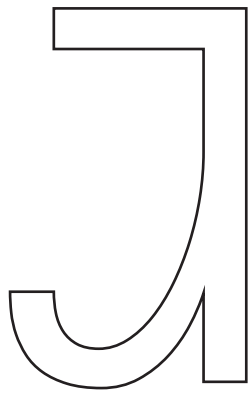
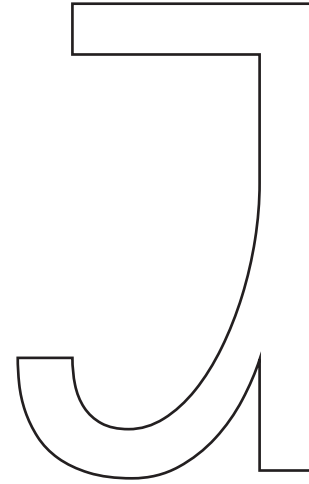
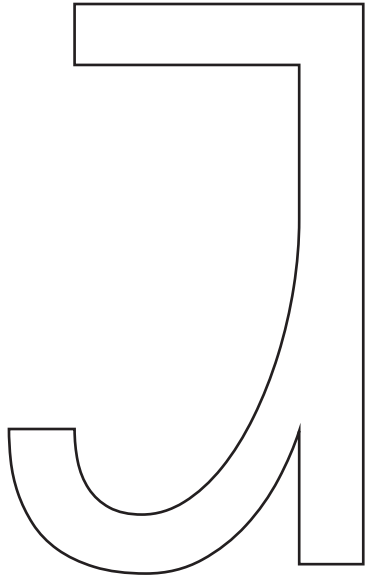

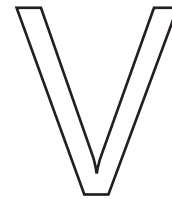
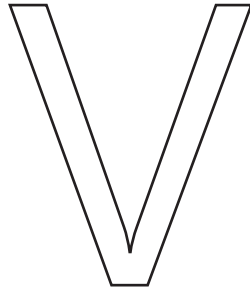
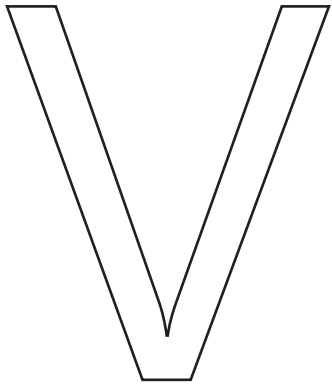
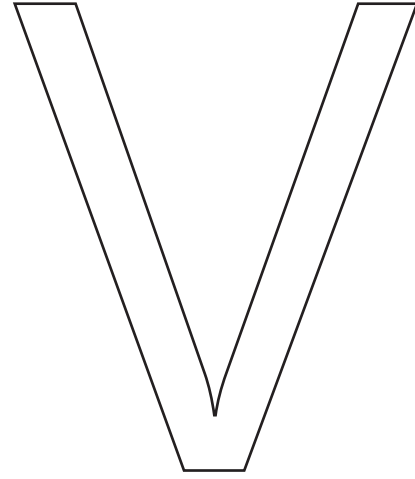
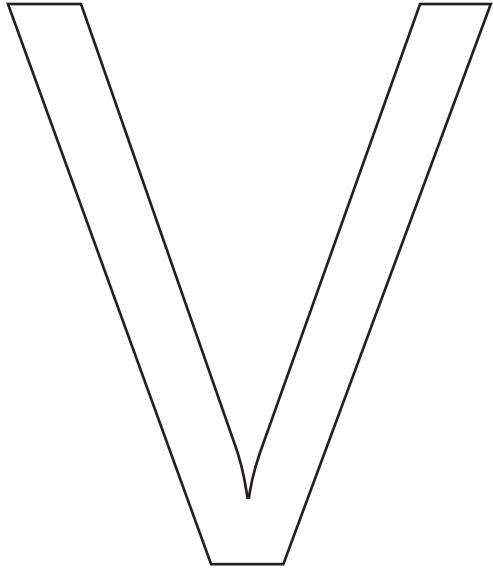

S

S

S

S

s



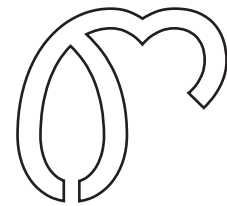
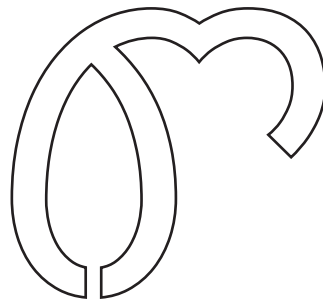
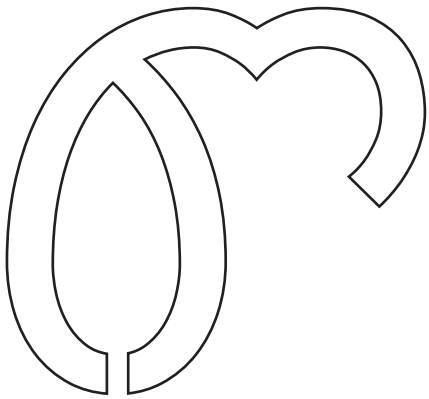
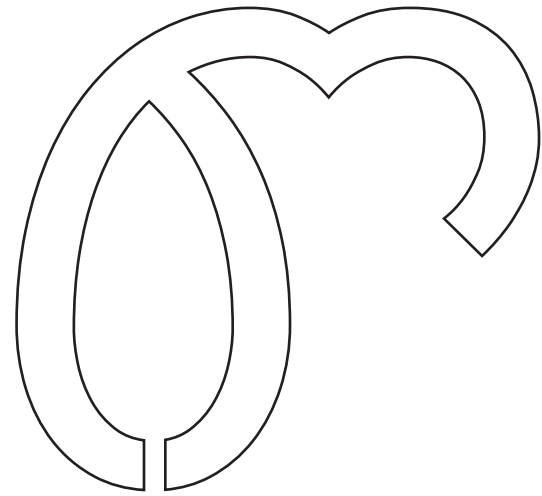
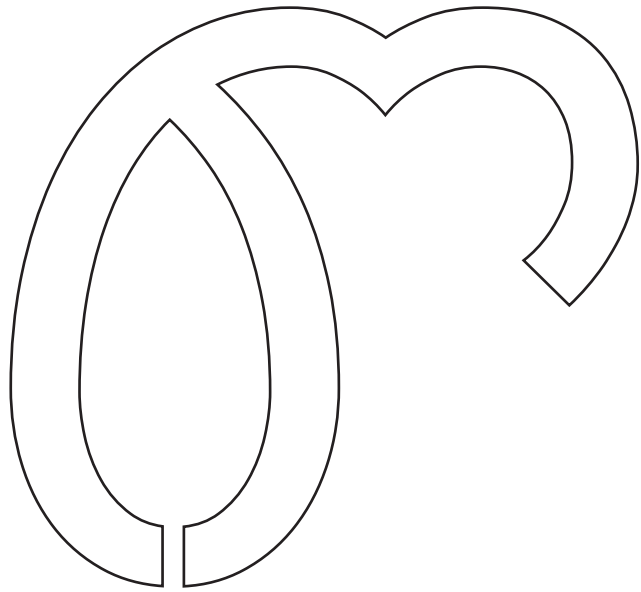

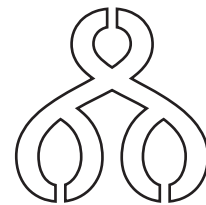
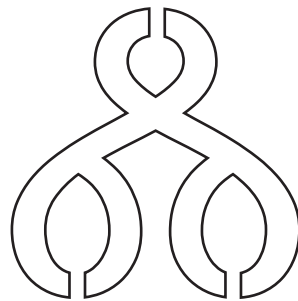
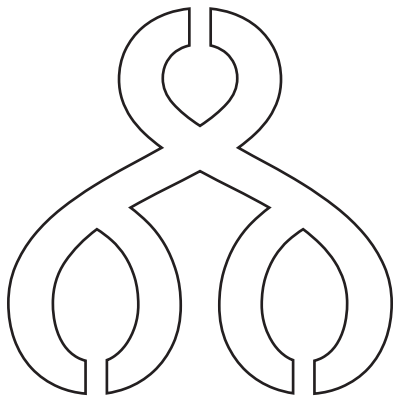
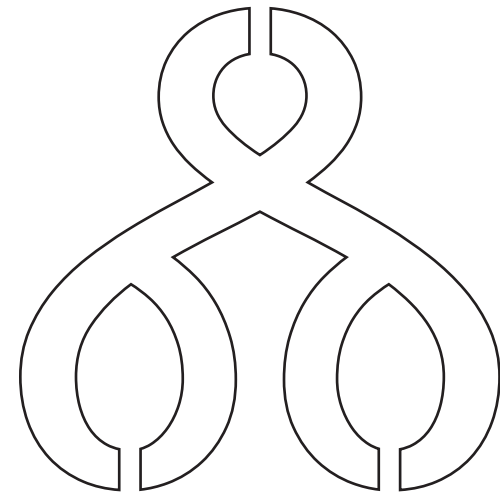
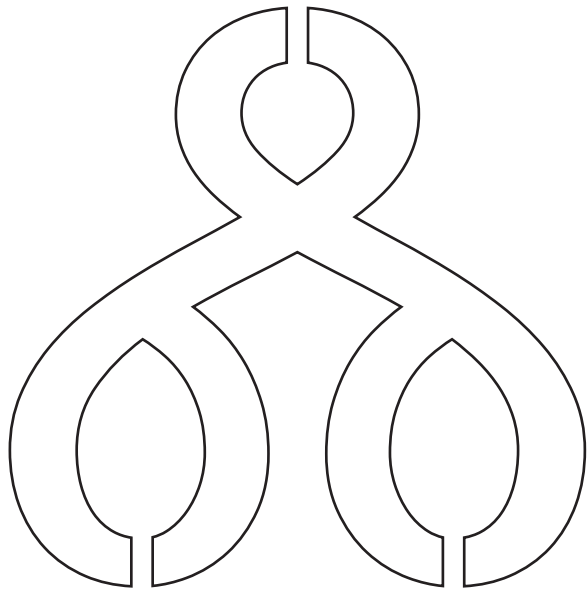

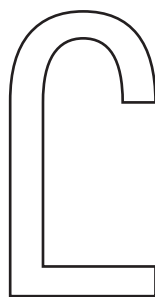
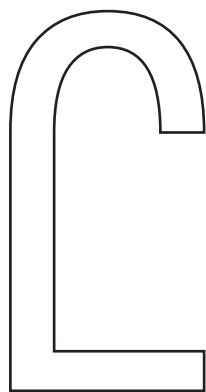
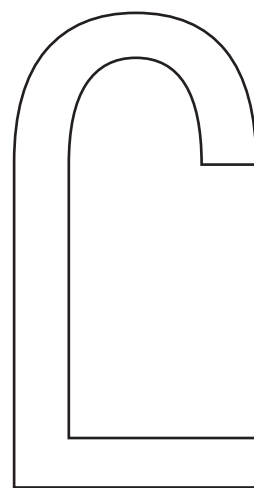
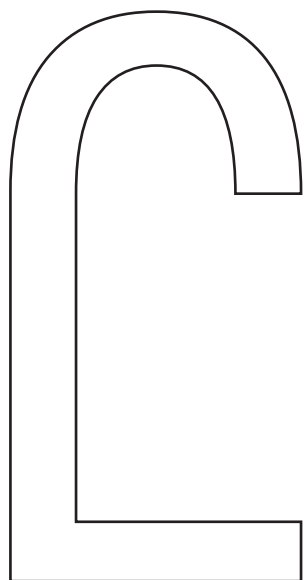

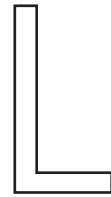
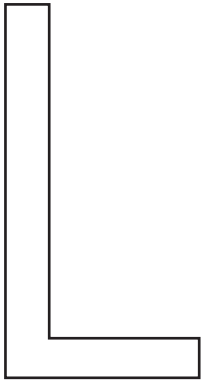
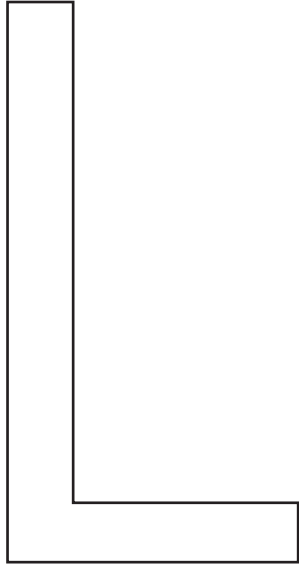

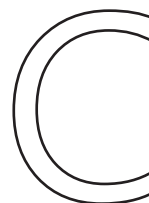
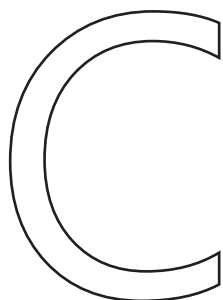
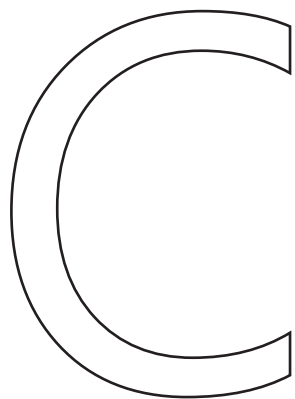
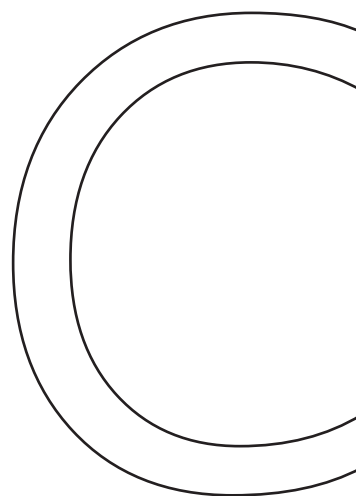
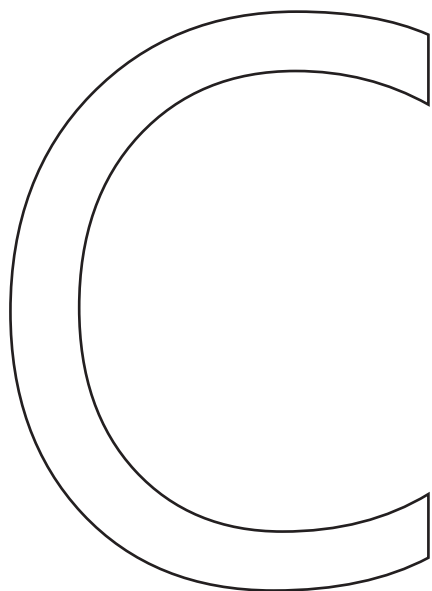

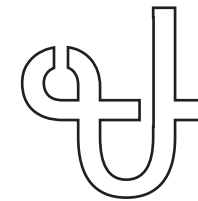
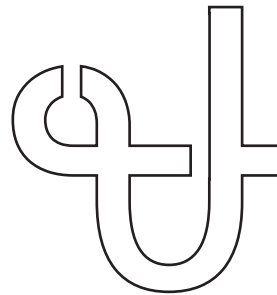
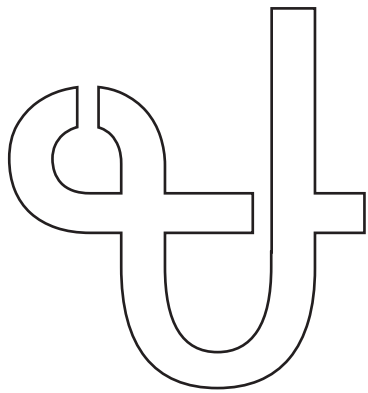
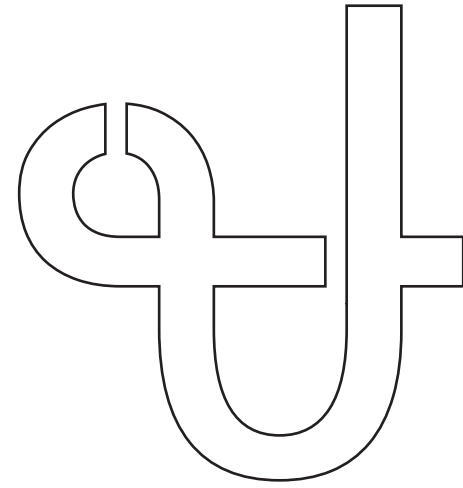
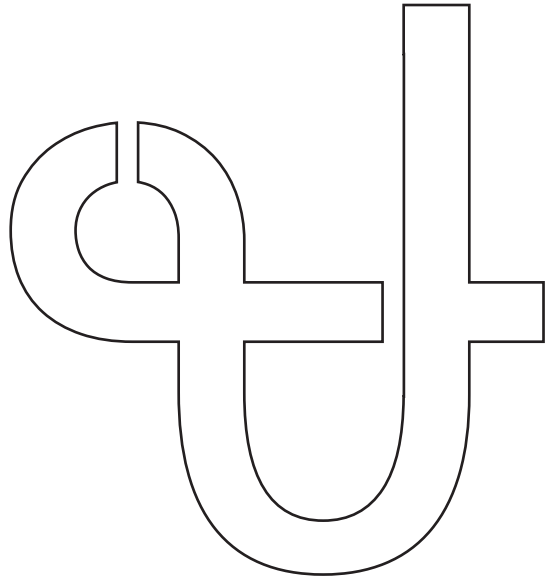

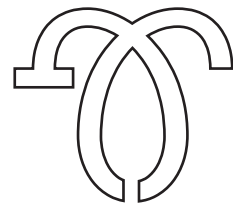
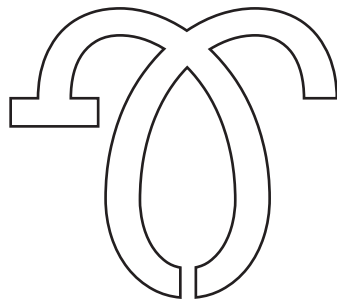
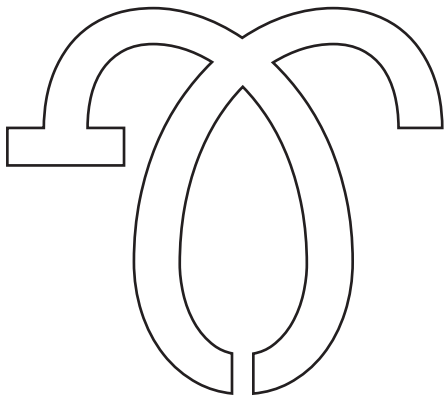
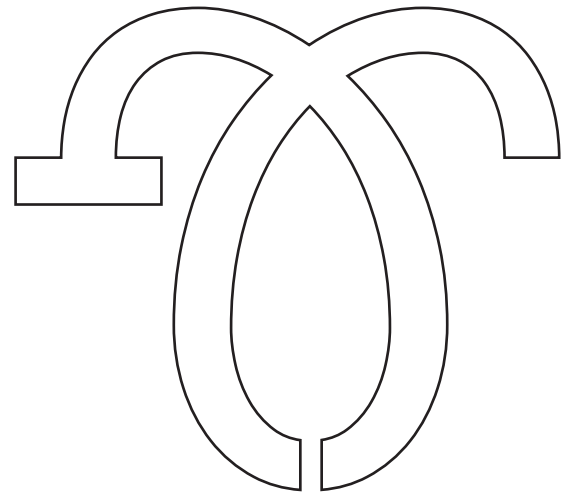
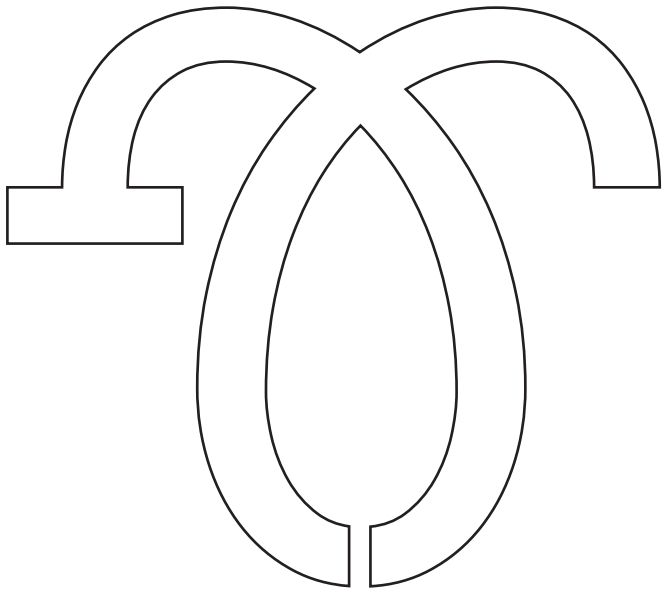

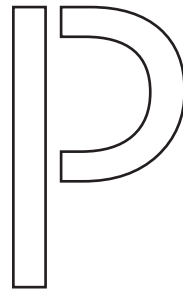
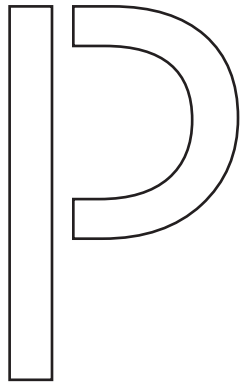
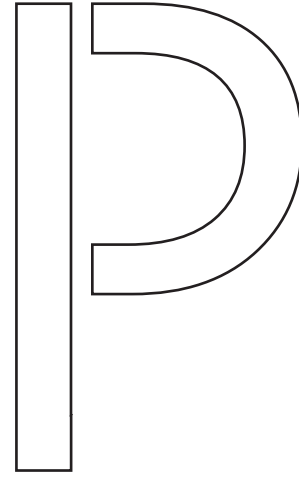
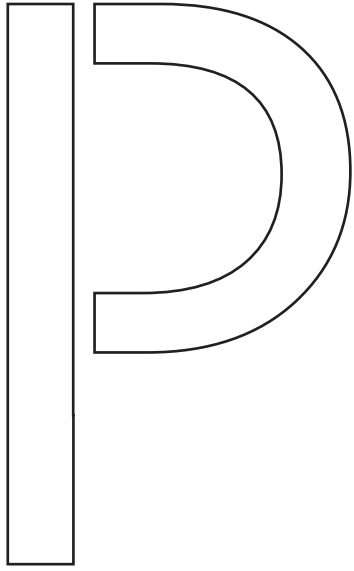



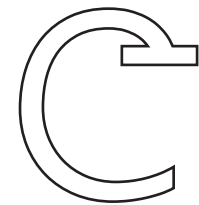
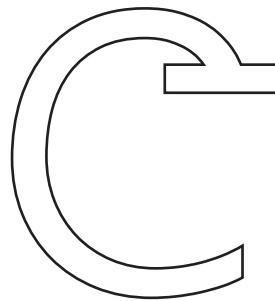
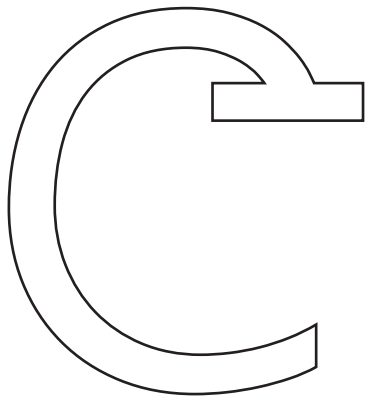
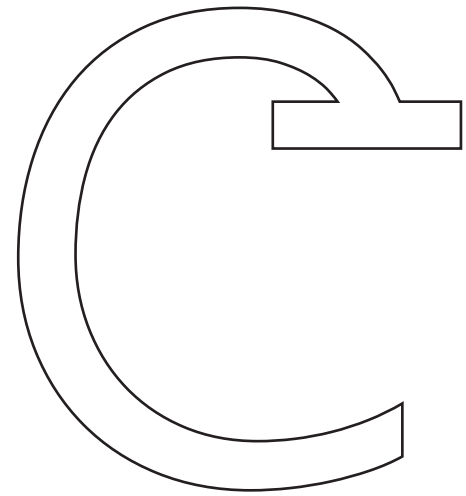
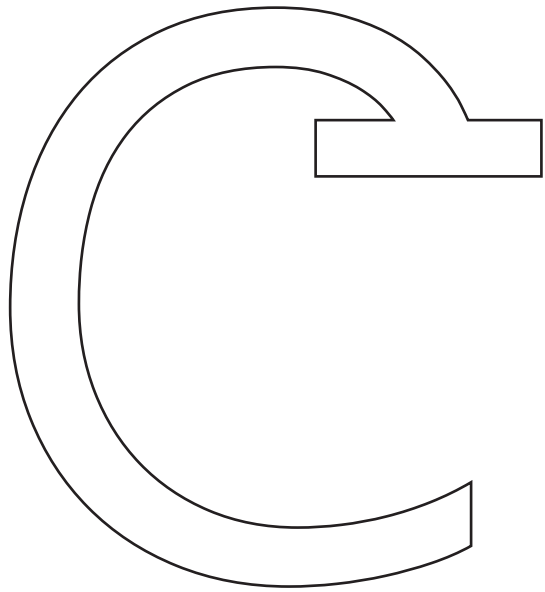

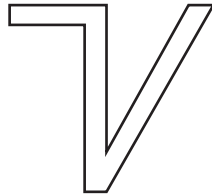
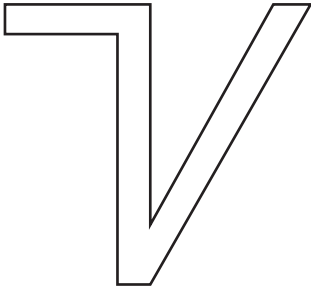
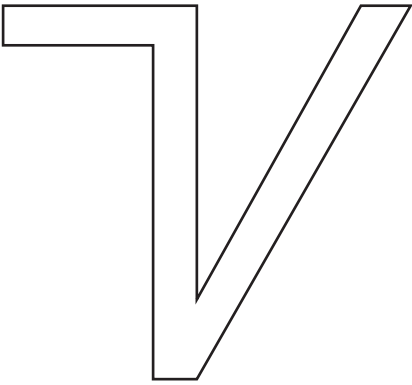
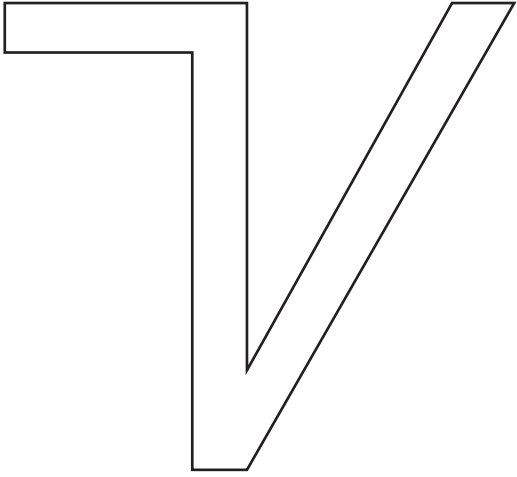
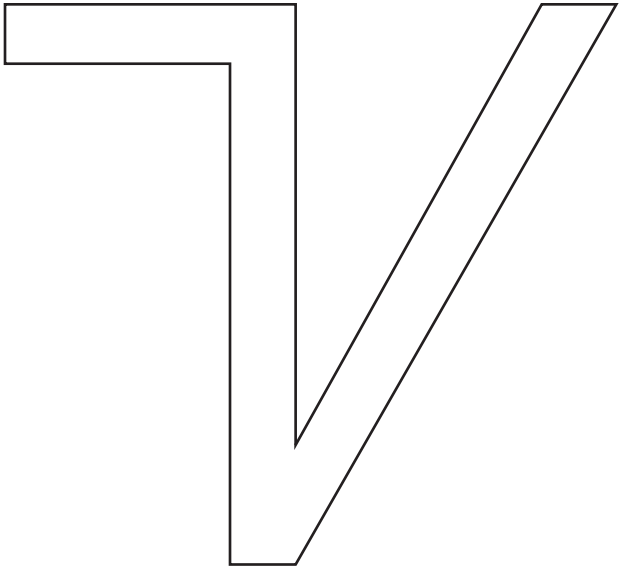

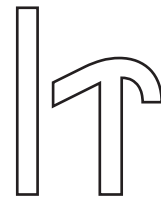
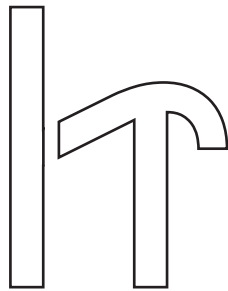
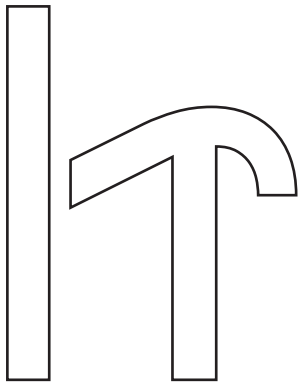
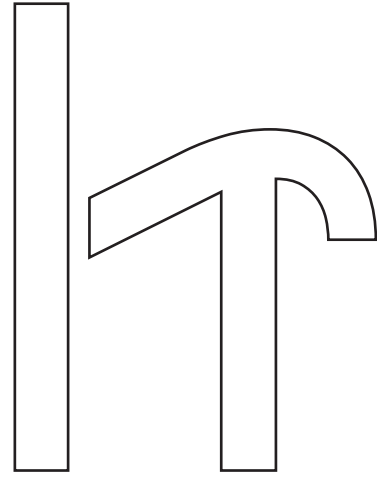
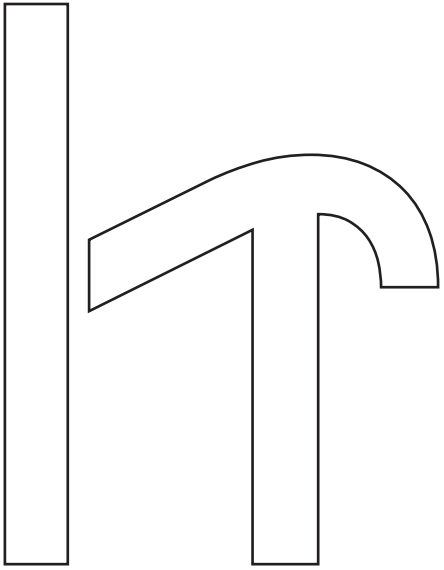

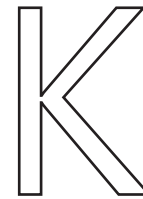
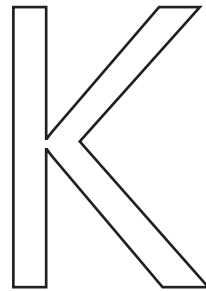
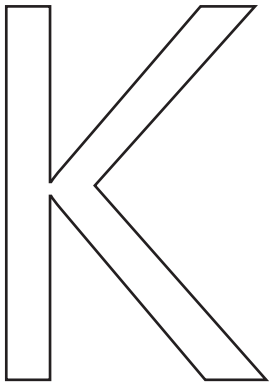
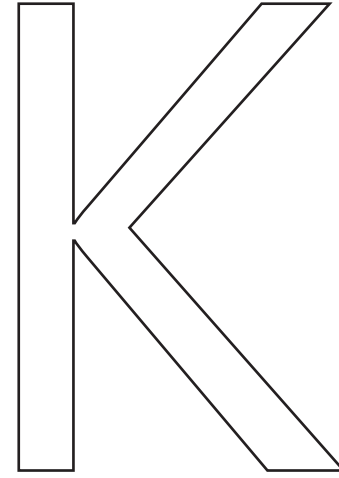
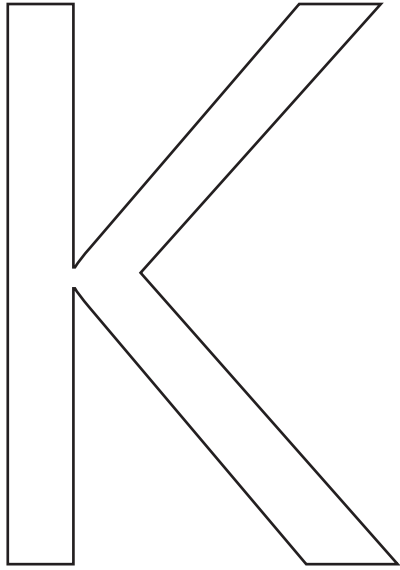

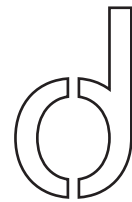
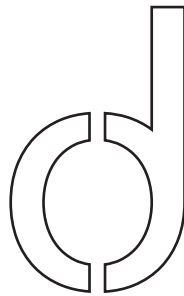
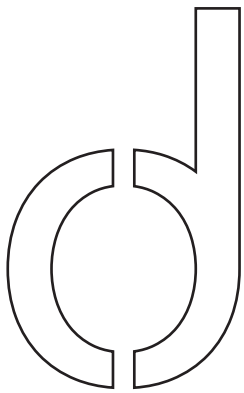
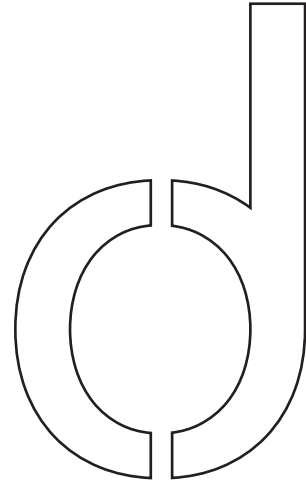
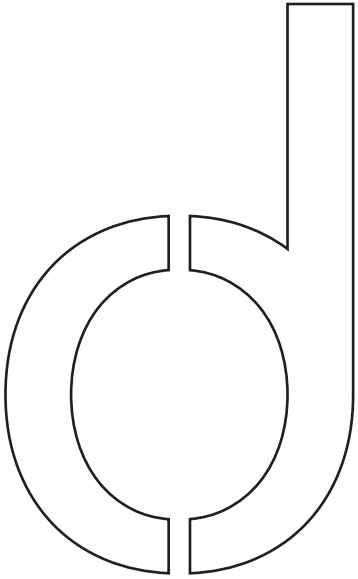

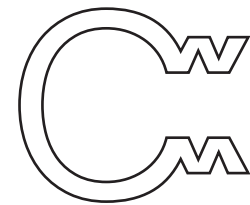
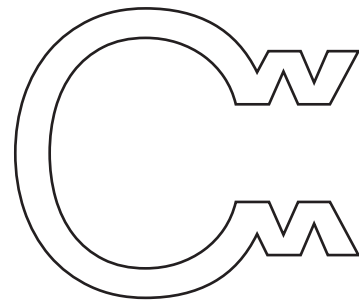
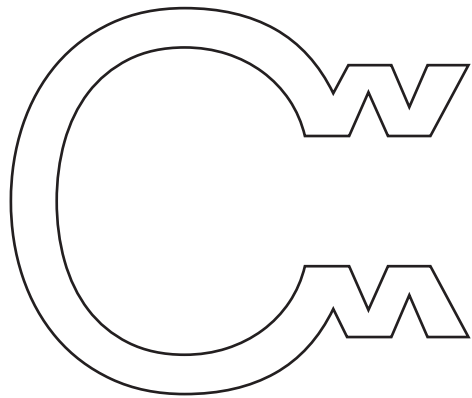
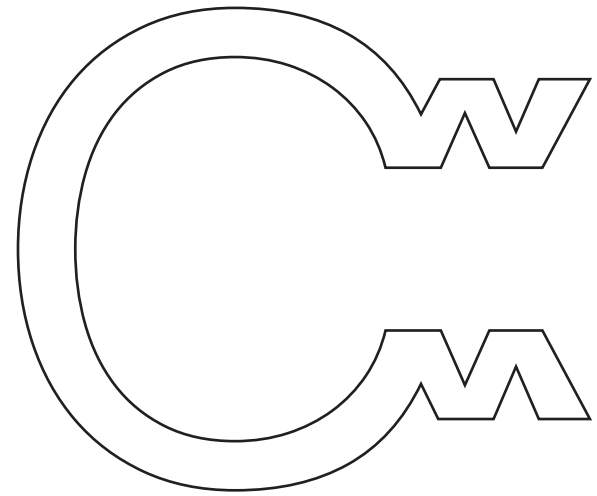
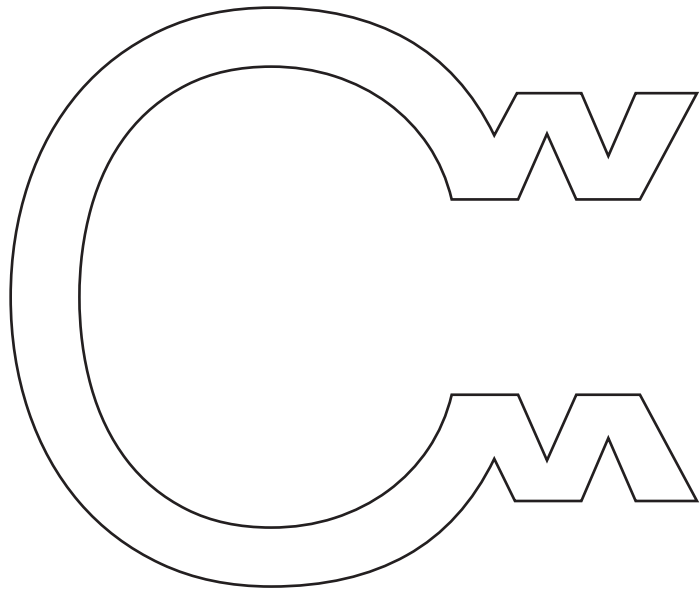

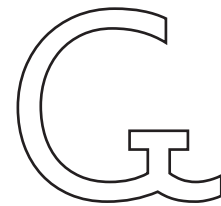
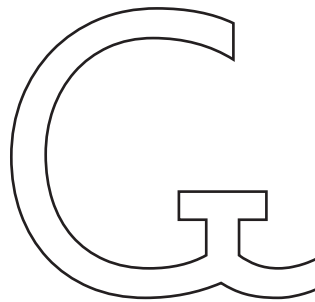
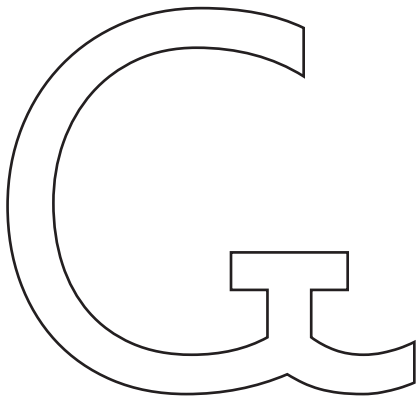
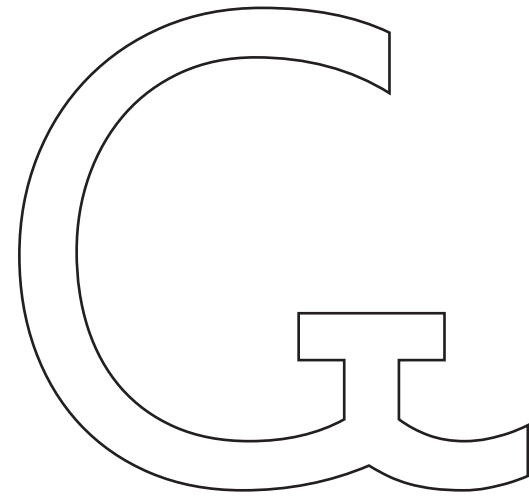
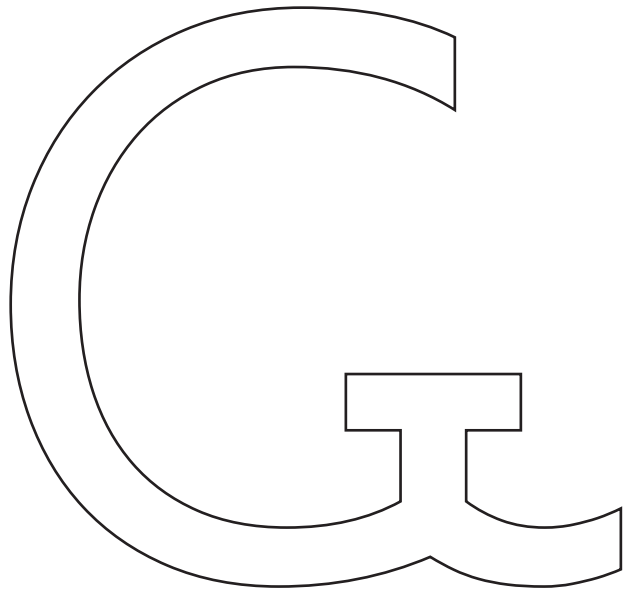

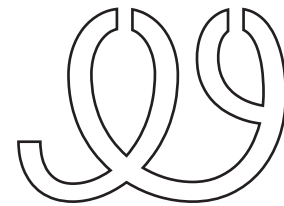
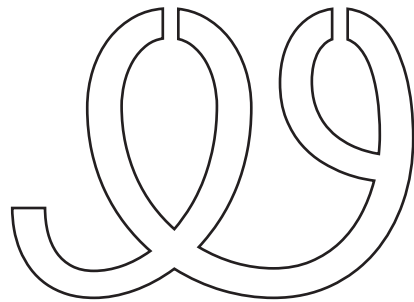
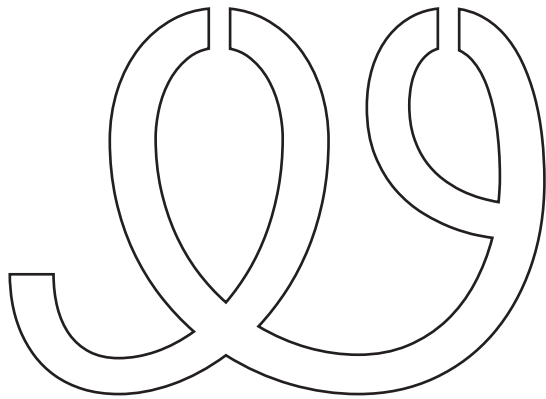
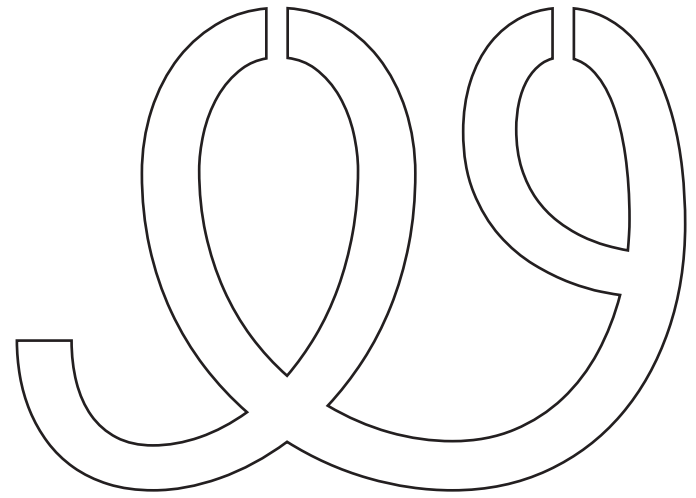
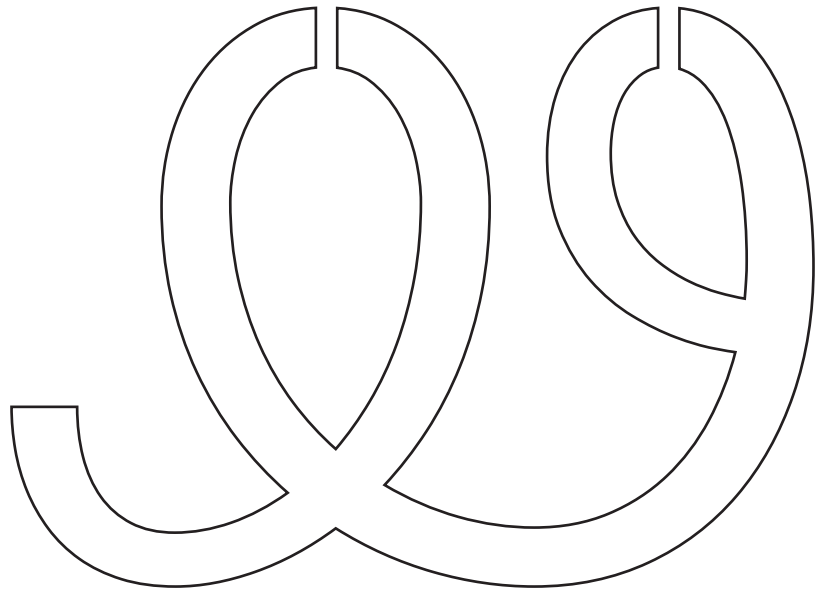



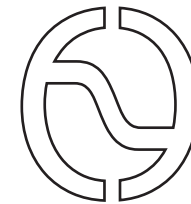
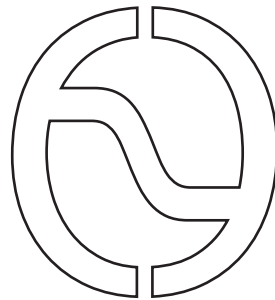
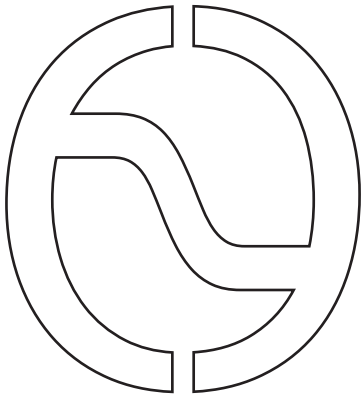
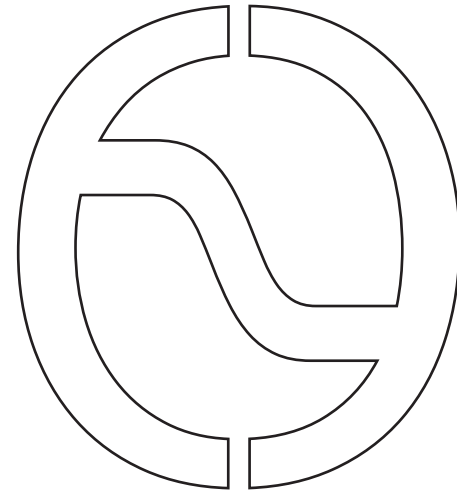
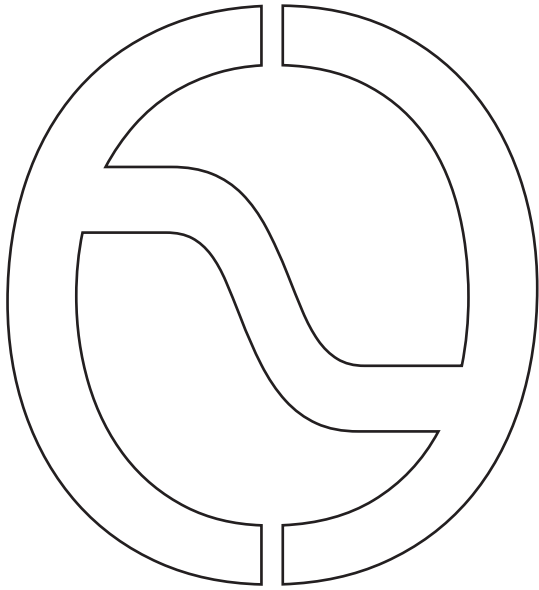

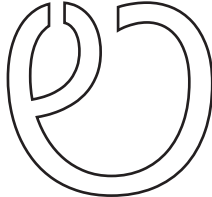
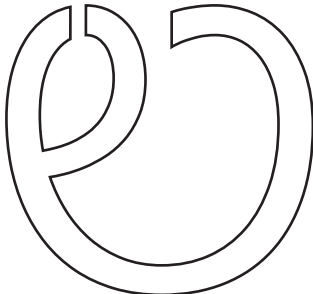
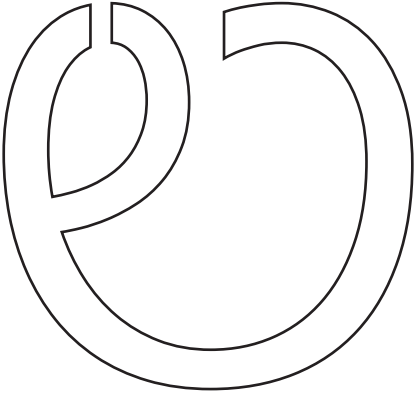
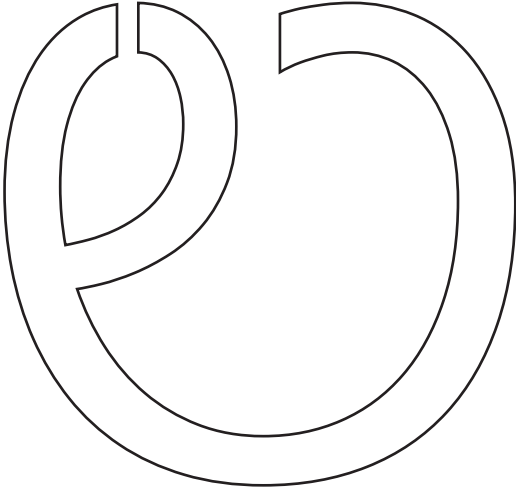
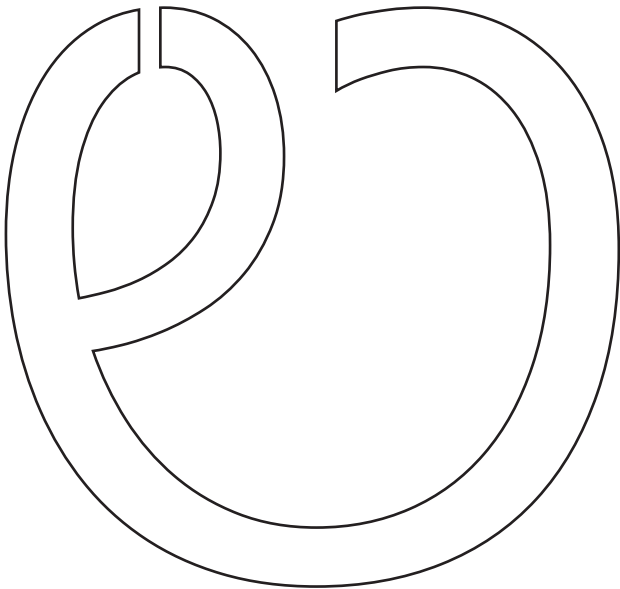

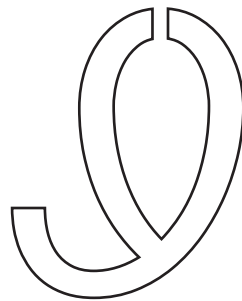
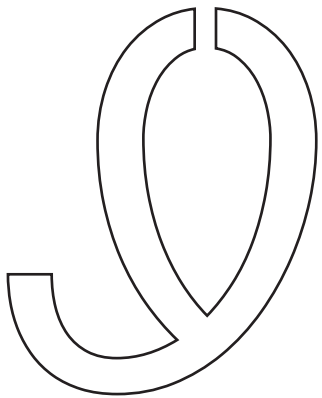
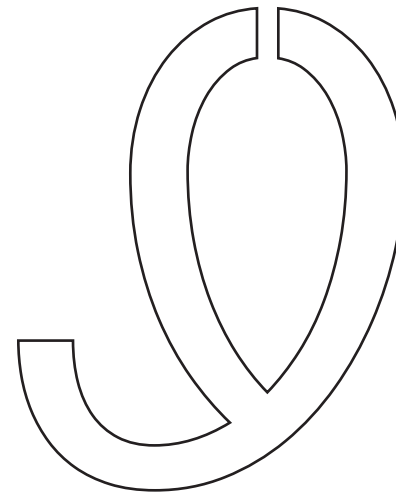
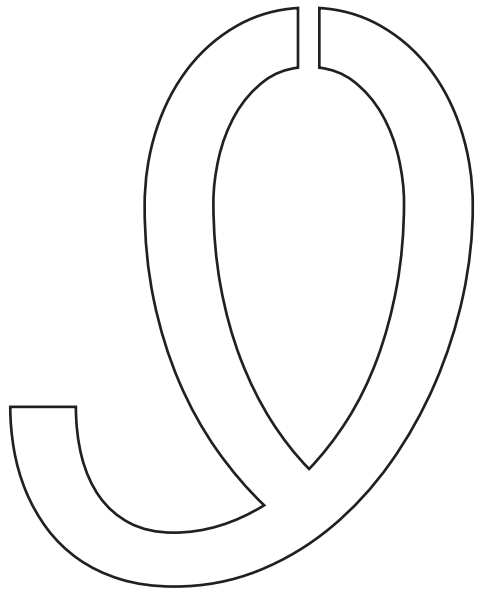

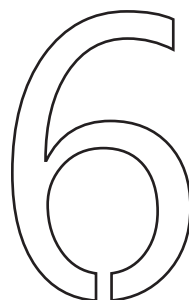
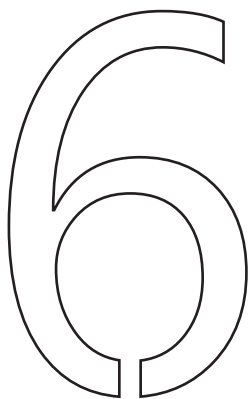
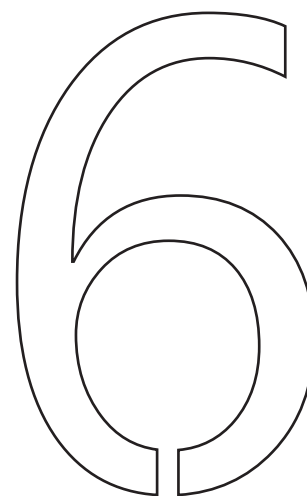
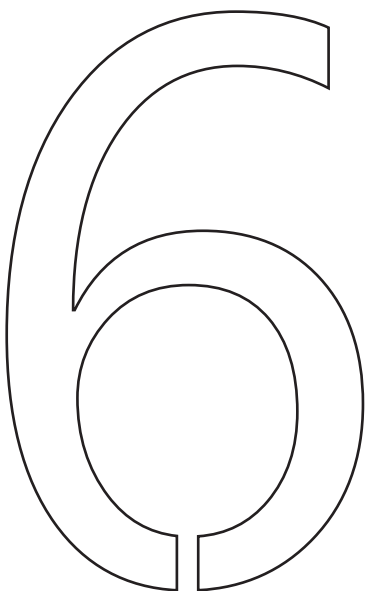

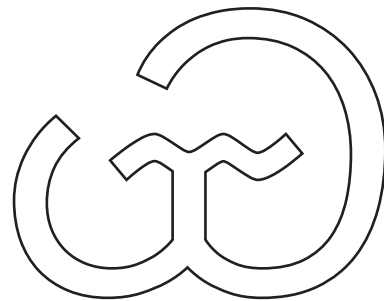
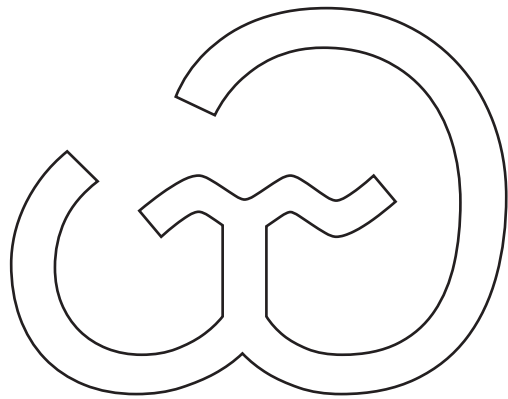
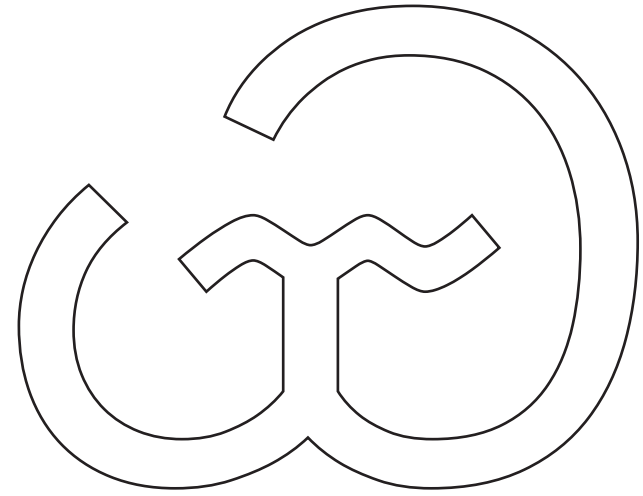
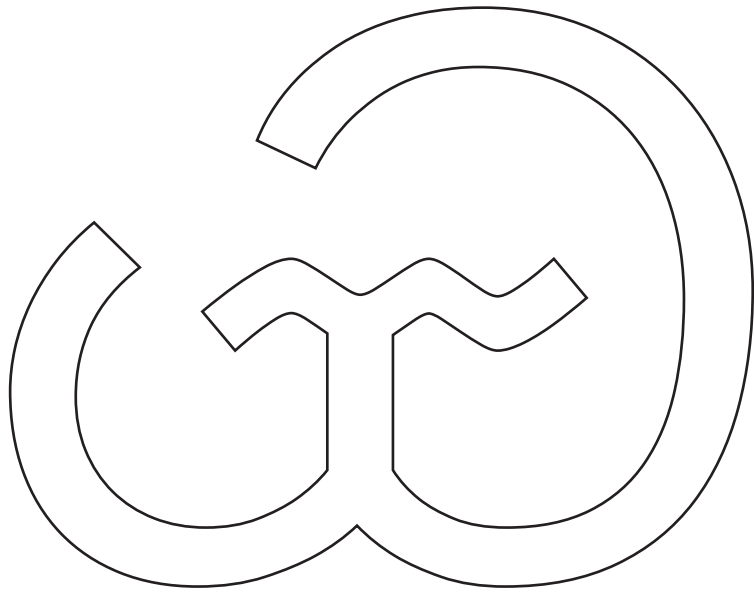

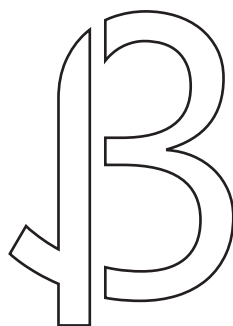
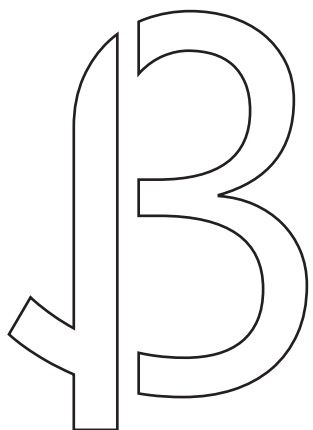
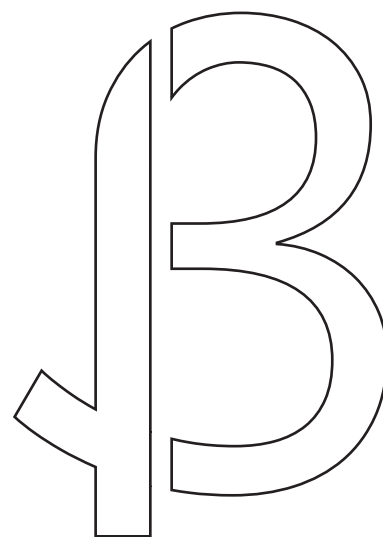
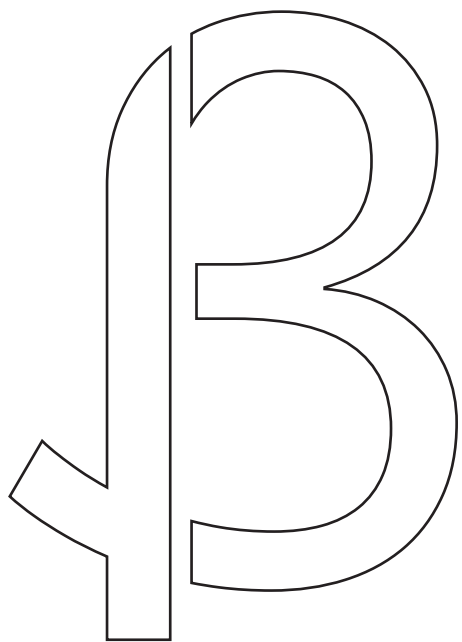

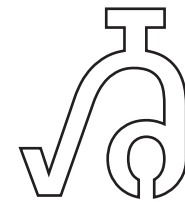
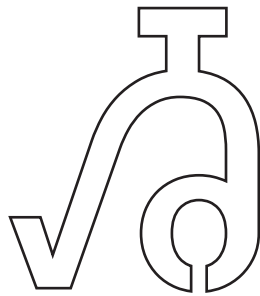
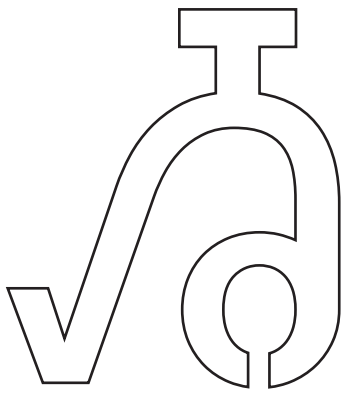
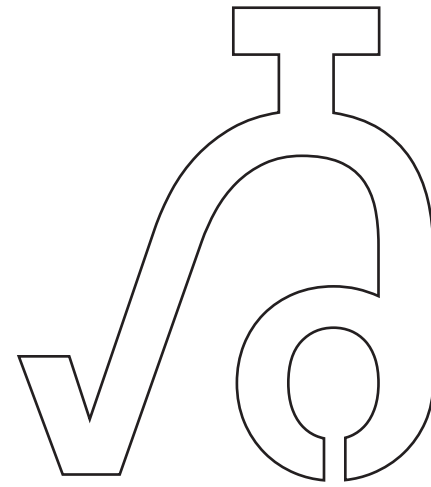
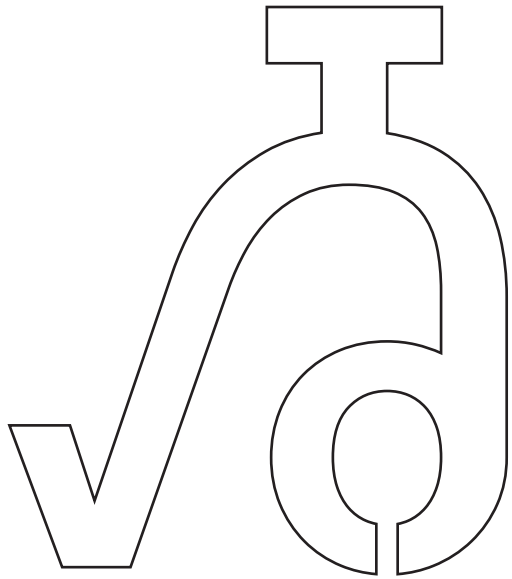

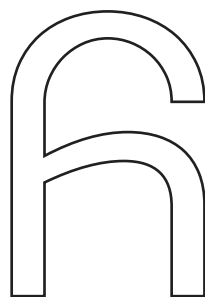
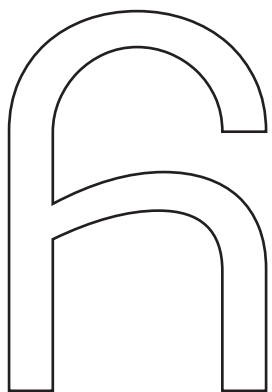
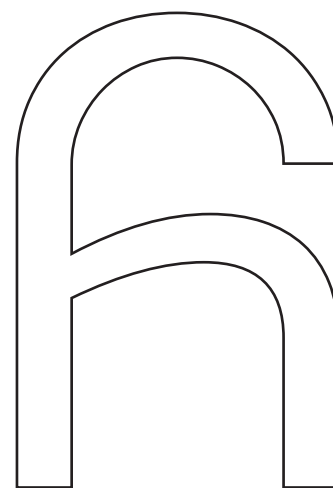
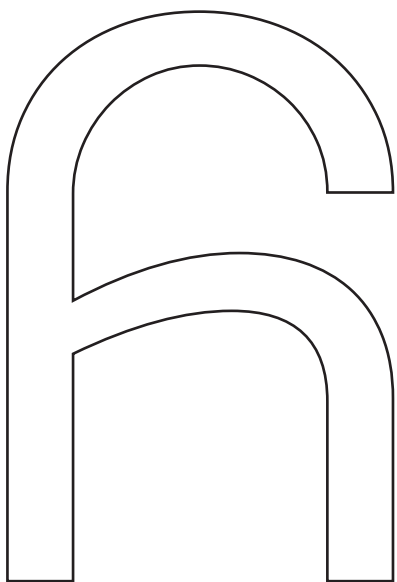



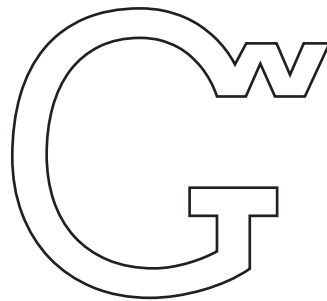
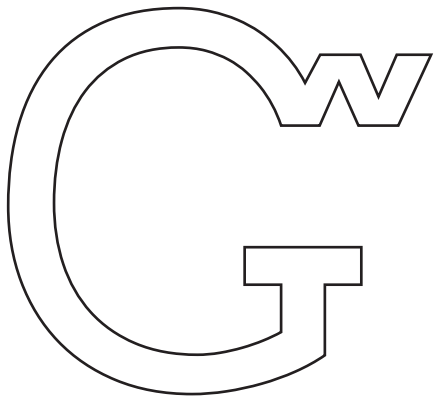
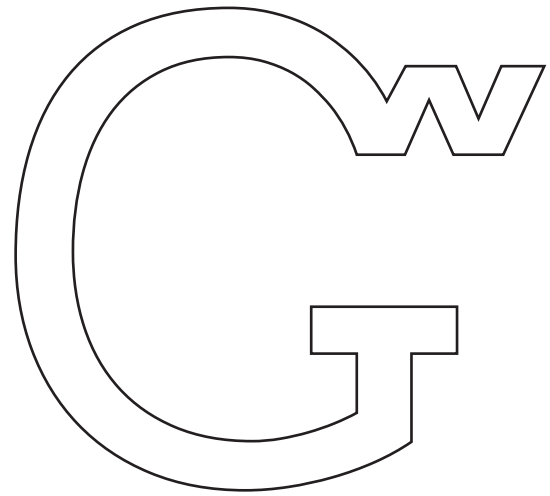
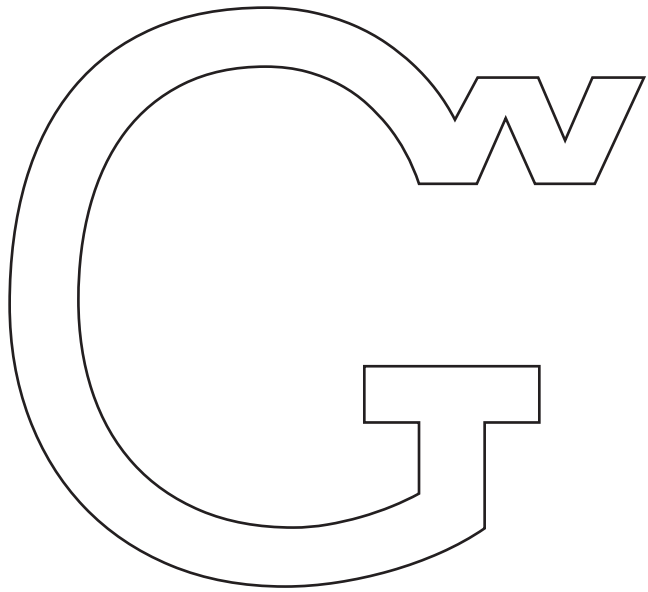

B

B

B

B

B