

Brought to you by Cherokee Nation Education

- Coloring pages
- Puzzles
- Cherokee Word Search

ᏊᏗᏗᏗᏗ ᏊᏗᏗᏗᏗ

Language Technology

Cherokee First

Children's Activity Book



Color the Cherokee Nation Seal



	1 a	2 e	3 i	4 o	5 u	6 v
1 Vowels	D	R	T	ᵐ	ᵒ	i
2 g	ᶑ ᵐ	ᶒ	y	A	J	E
3 h	ᶑ	ᶒ	ᶓ	ᶔ	ᶕ	ᶖ
4 l	W	ᶑ	ᶒ	G	M	ᶓ
5 m	ᶑ	ᶒ	H	ᶓ	y	G
6 n/hn	ᶑ ᶒ G	ᶓ	h	Z	ᶔ	ᶕ
7 qu(ku)	I	ᵐ	ᶑ	ᶒ	ᵐ	ᵎ
8 s	ᶑᶒ	4	b	ᶑ	ᶒ	R
9 d/t	ᶑ W	ᶑ ᶒ	ᶑ ᶒ	V	S	ᶑ
10 dl/tl	ᶑ ᶒ	L	C	ᶑ	ᶒ	P
11 ts	ᶑ	ᶒ	ᶓ	K	d	ᶑ
12 w/(h)w	G	ᶑ	ᶒ	ᶓ	ᶔ	ᶕ
13 y/(h)y	ᶑ	ᶒ	ᶓ	ᶔ	ᶕ	B

Help ኮሎንል find the Syllabary

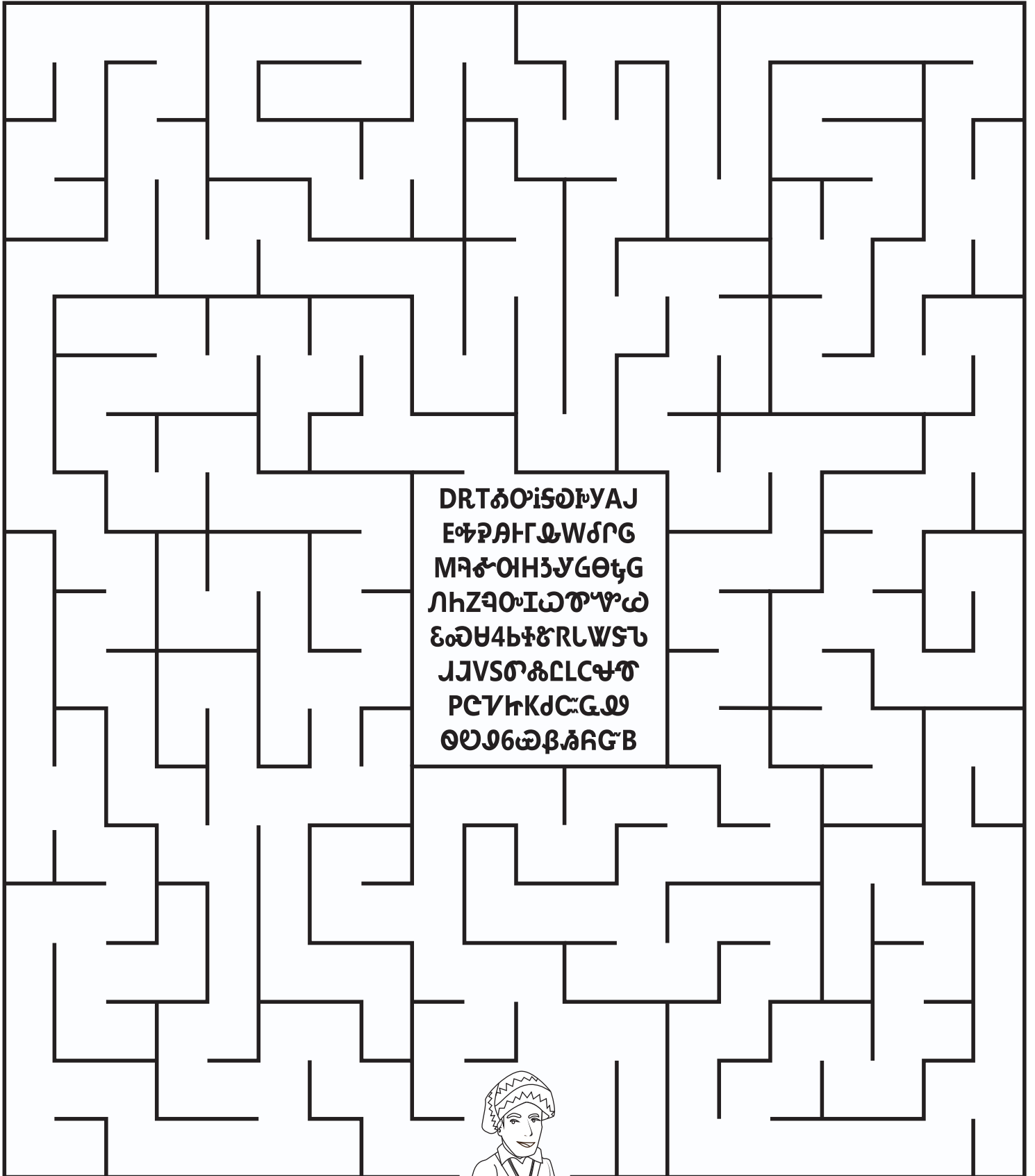

DRTፊዕ፤ፍዕኮሃላገ
ፎቲፖላ፡ፈግፊፍፍ
ጠፋፊ፡ዕዘፊፍፍፍፍ
ለከፊፍ፡ፈፍፍፍፍፍ
ፍፍፍፍ፡ፍፍፍፍፍፍ
ገፍፍፍ፡ፍፍፍፍፍፍ
ፍፍፍ፡ፍፍፍፍፍፍ
ፍፍፍ፡ፍፍፍፍፍፍ

Dከሃፍፍፍፍፍፍ



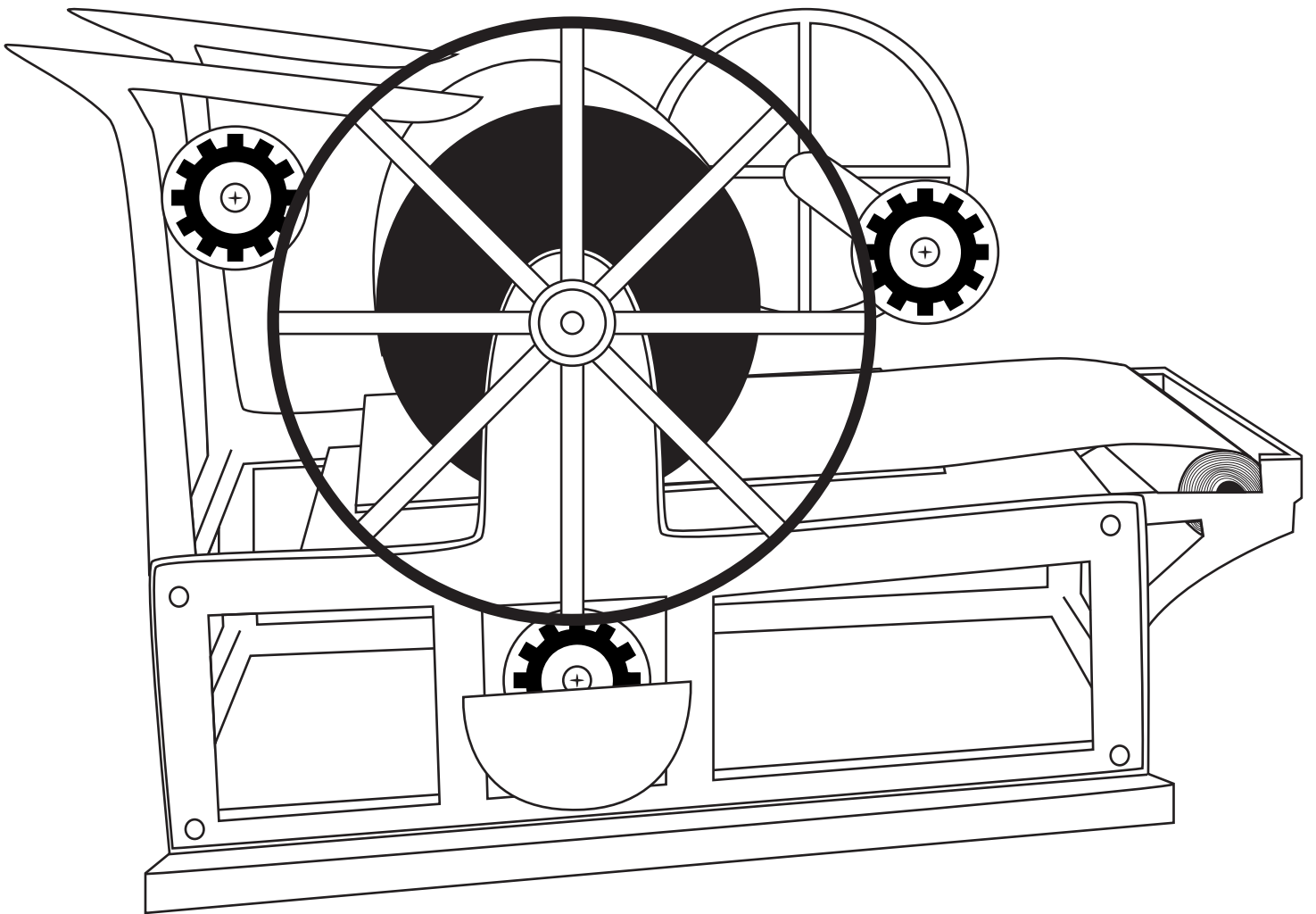

**JAᏉᏉᏉ ᏉZᏉᏉ D4 JAᏉᏉᏉ ᏉᏉᏉᏉᏉ ᏉᏉᏉ
ᏉᏉᏉᏉᏉ ᏉᏉᏉᏉ. ᏉᏉ ᏉᏉᏉᏉᏉᏉᏉᏉ
JAᏉᏉᏉ ᏉᏉᏉ ᏉᏉᏉ ᏉᏉᏉ ᏉᏉᏉᏉᏉ
ᏉᏉᏉᏉᏉ ᏉᏉᏉᏉᏉᏉᏉ.**

Draw Sequoyah & The Cherokee Syllabary

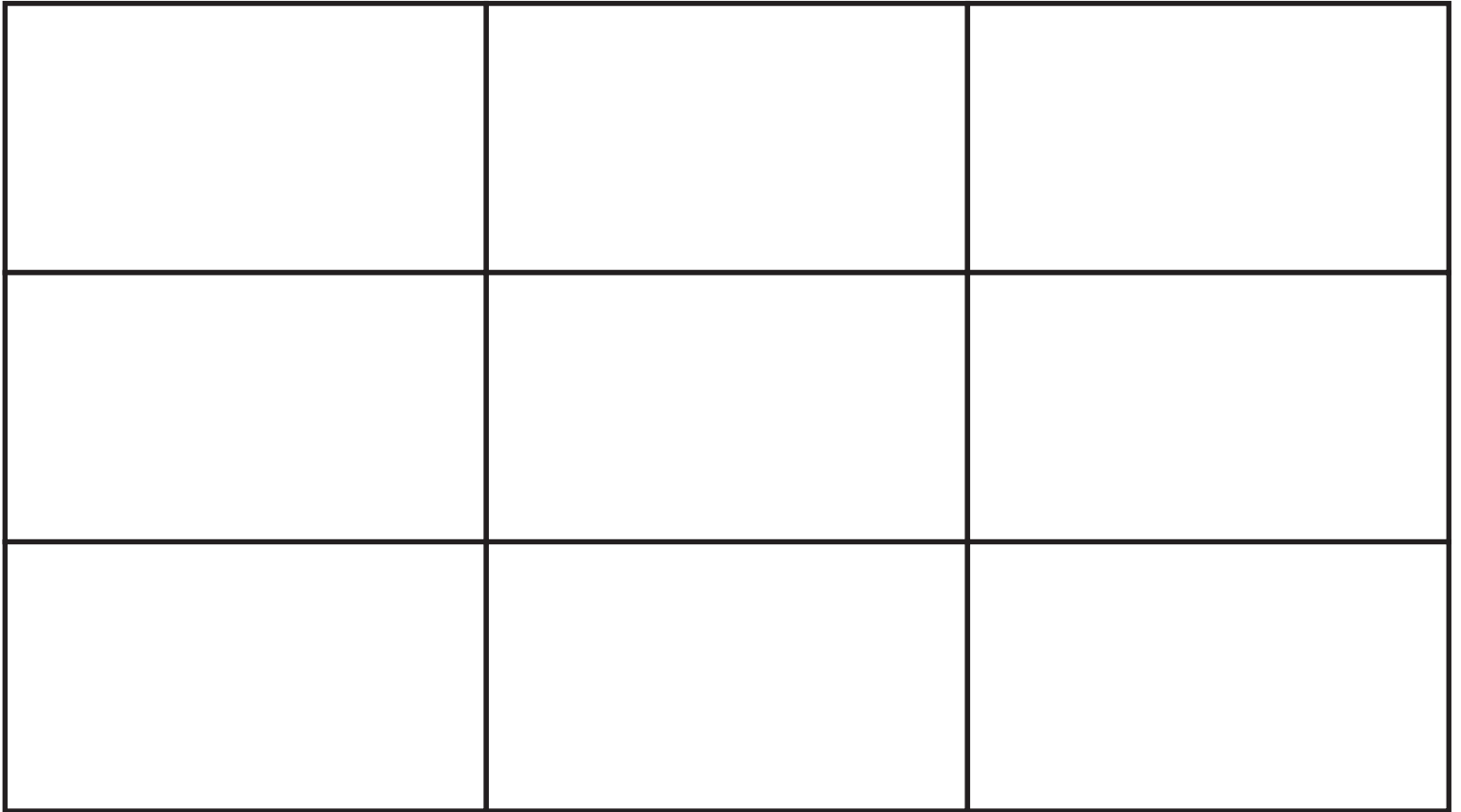
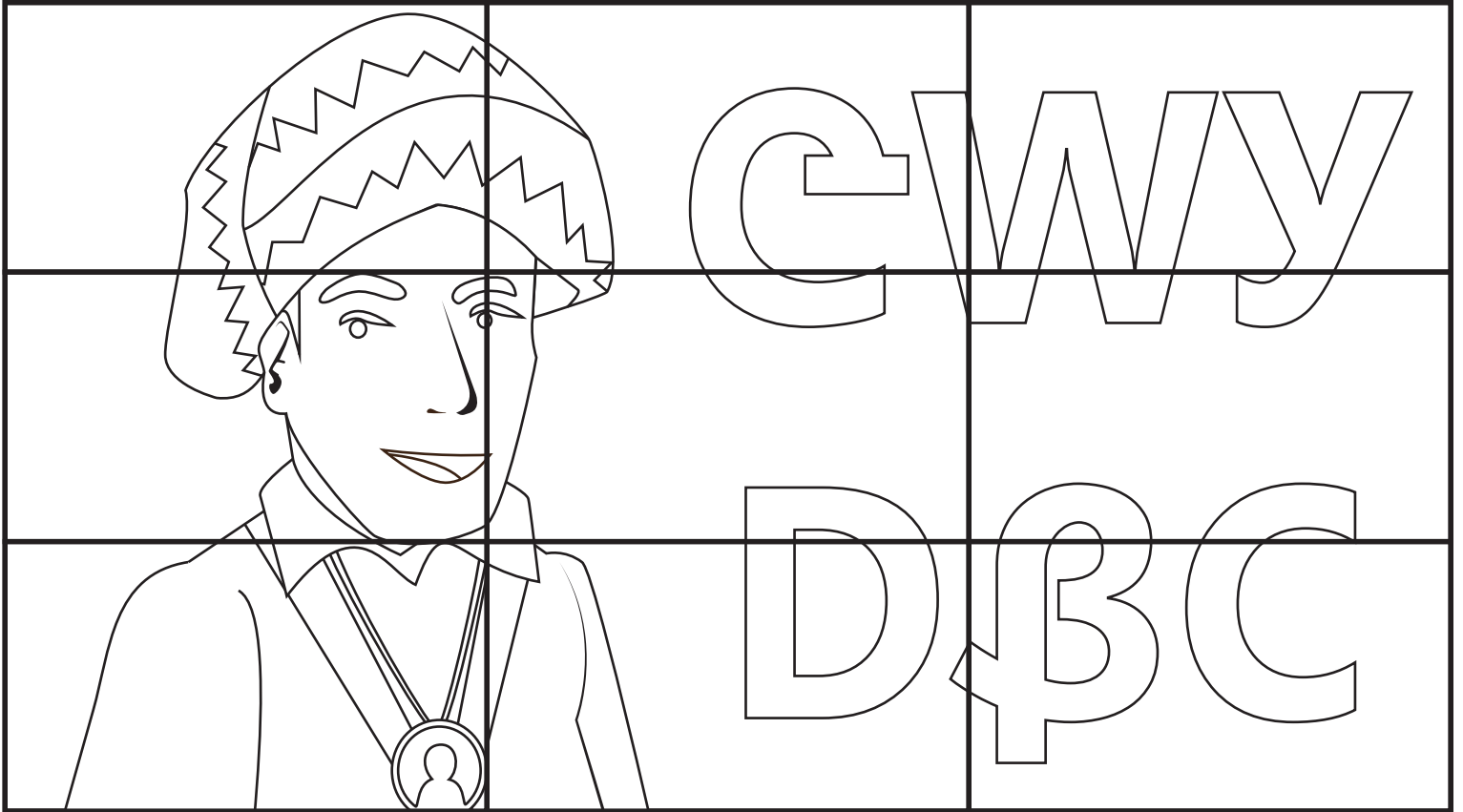



ԼԻՃԲԱՅԻՆ ԼՕՄԻՃԻՒՄ, ՅՈՒՅ ԸՄՄ ԸՅՐ
ՏԻՃԲՈՒ ՄԵՆԻՂ յԱՅՐ ՏԻՅԻՒ, յԵԶԵՐՈՅ
յԱՅՐ, ԸՃ ՅՈՒՅ ԸՄՄ ՄԵՆԻՅՈՒ ԸԵՃ
ԸԻՅԵՅԵՐ ՄԻՃԲՈՒՅ ԱՅՐ Ե՛Ւ ԵԶՔՔ
ԻՐՈՒՅՈՒՅՈՒՅ.

Word Search

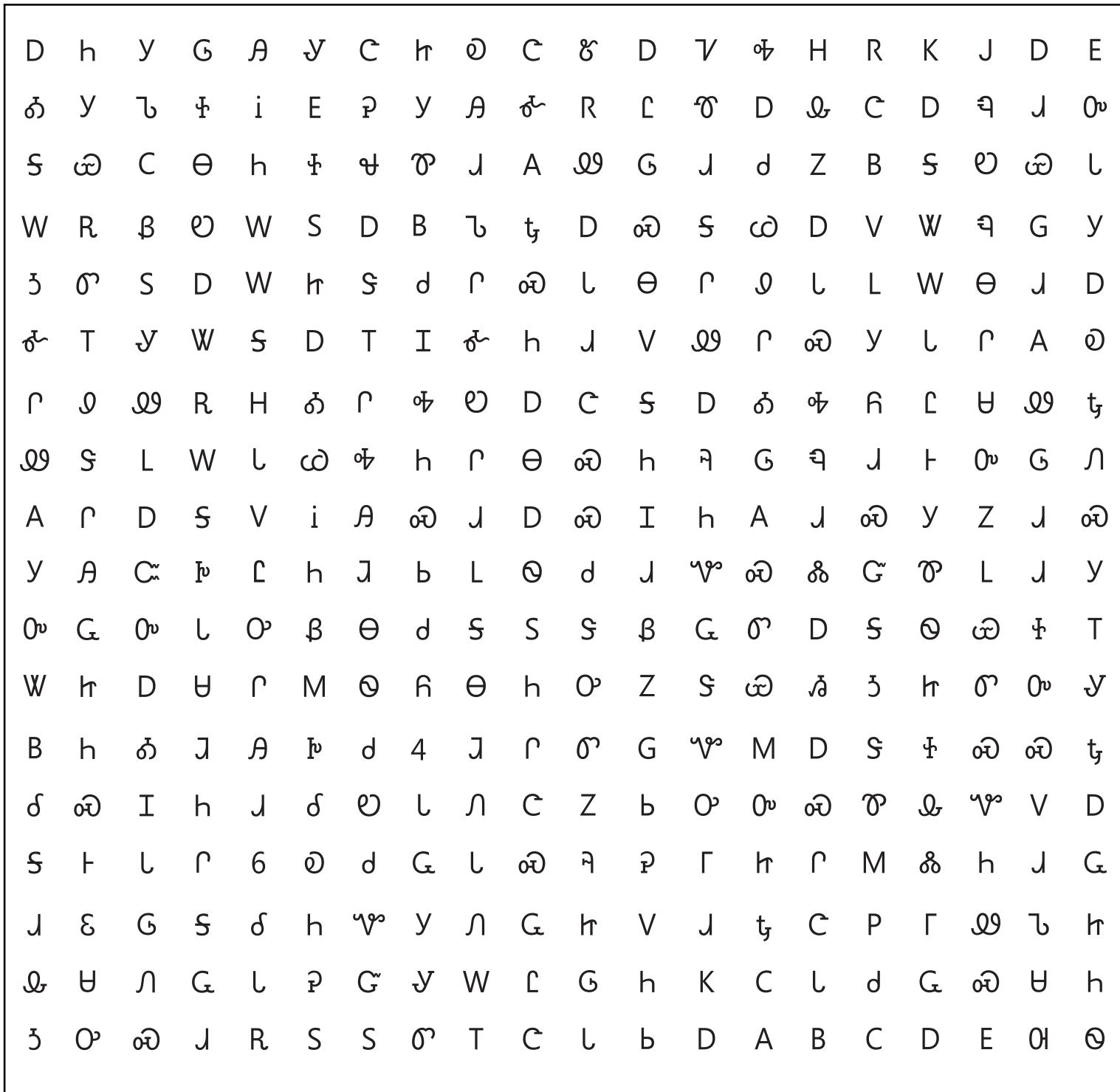

70WHT

∅0RZPJ

b∞∞

h∞5H

CWY ∅∅A∅0A

JA∞GJ ∅ZBS

JV∞∞∞Y

J5∅BWOY A∞∞

JA∞GJ J40∞∞VJ

DSViA∞J D∞∅IhAJ∞Y

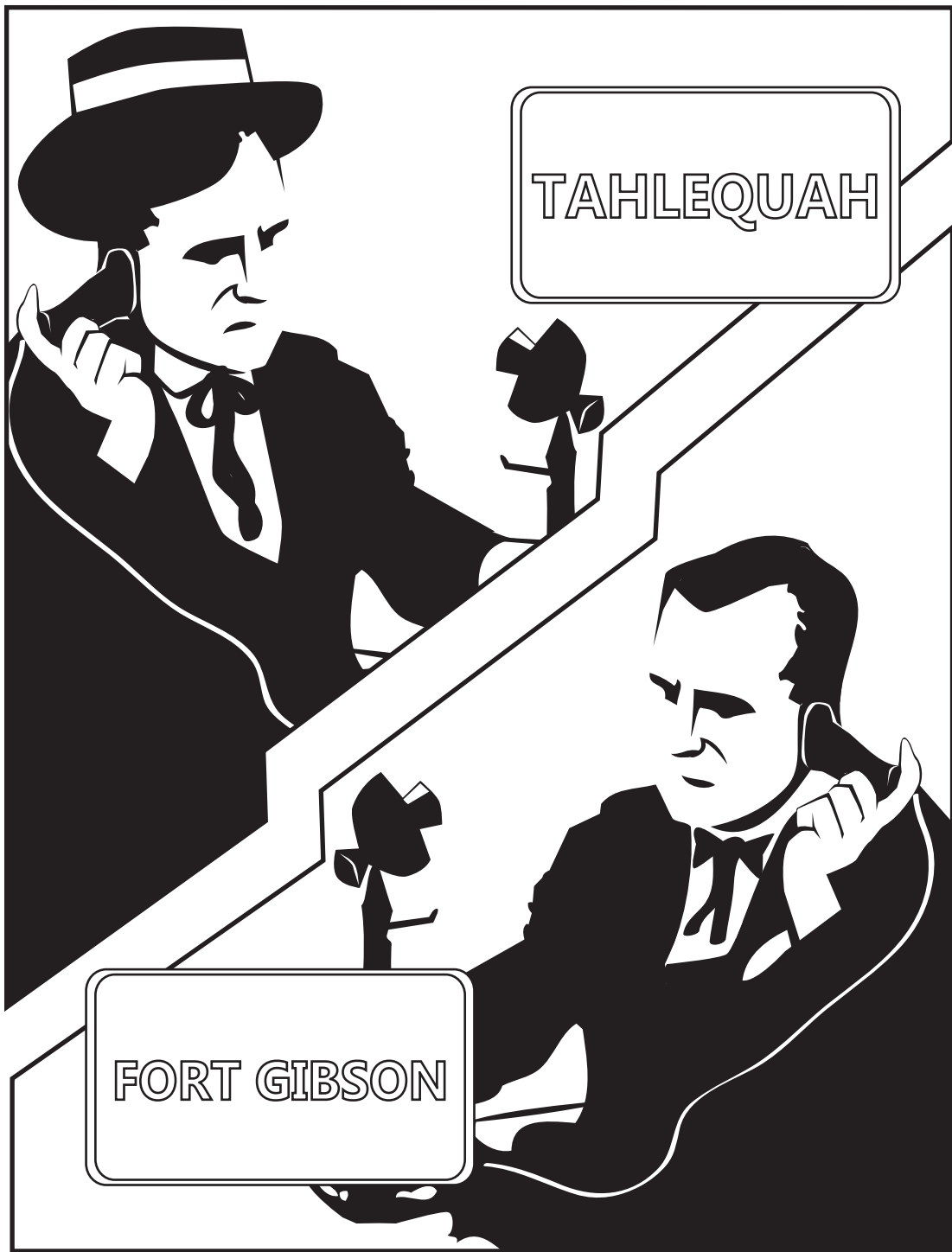

ՕՂԸ ԺՏՂԵԼ ՕՂՐԿ ԹՈՎԿ ԸԻՇԿԿ ԺԻՄՇ
ԸՖՏ ԸԻԹՈՒՈՒՐ ՈՒՏՏԿ, ՇԿԿ ԸՅՐ ՕՒՈՒՏ
ՕԻԻԿՐՕՒԿ ԺԹՐԶՔՂ ԹՂԼԳՂՏ ԹՈՎԿ ԸԸՂՏ
ՉՐՈՎԿՕՒ ԸՖԹՂԸ ՕՏՐԸ ԸՈՎԿԻԿ ՐՆՊԻ
ՕՁՅՏ.

Trace the Cherokee Syllabary Characters

D		R		T		Ꭰ		Ꭱ		Ꭲ	
Ꭳ	Ꭴ	Ꭵ		Ꭶ		Ꭷ		Ꭸ		Ꭹ	
Ꭺ		Ꭻ		Ꭼ		Ꭽ		Ꭾ		Ꭿ	
Ꮀ		Ꮁ		Ꮂ		Ꮃ		Ꮄ		Ꮅ	
Ꮆ		Ꮇ		Ꮈ		Ꮉ		Ꮊ		Ꮋ	
Ꮌ		Ꮍ		Ꮎ		Ꮏ		Ꮐ		Ꮑ	
Ꮒ	Ꮓ	Ꮔ		Ꮕ		Ꮖ		Ꮗ		Ꮘ	
Ꮙ	Ꮚ	Ꮛ		Ꮜ		Ꮝ		Ꮞ		Ꮟ	
Ꮠ		Ꮡ		Ꮢ		Ꮣ		Ꮤ		Ꮥ	
Ꮦ		Ꮧ		Ꮨ		Ꮩ		Ꮪ		Ꮫ	
Ꮬ	Ꮭ	Ꮮ		Ꮯ		Ꮰ		Ꮱ		Ꮲ	
Ꮳ		Ꮴ		Ꮵ		Ꮶ		Ꮷ		Ꮸ	
Ꮹ		Ꮺ		Ꮻ		Ꮼ		Ꮽ		Ꮾ	
Ꮿ		Ᏸ		Ᏹ		Ᏺ		Ᏻ		Ᏼ	
Ᏽ		᏶		᏷		ᏸ		ᏹ		ᏺ	
ᏻ		ᏼ		ᏽ		᏾		᏿		᐀	

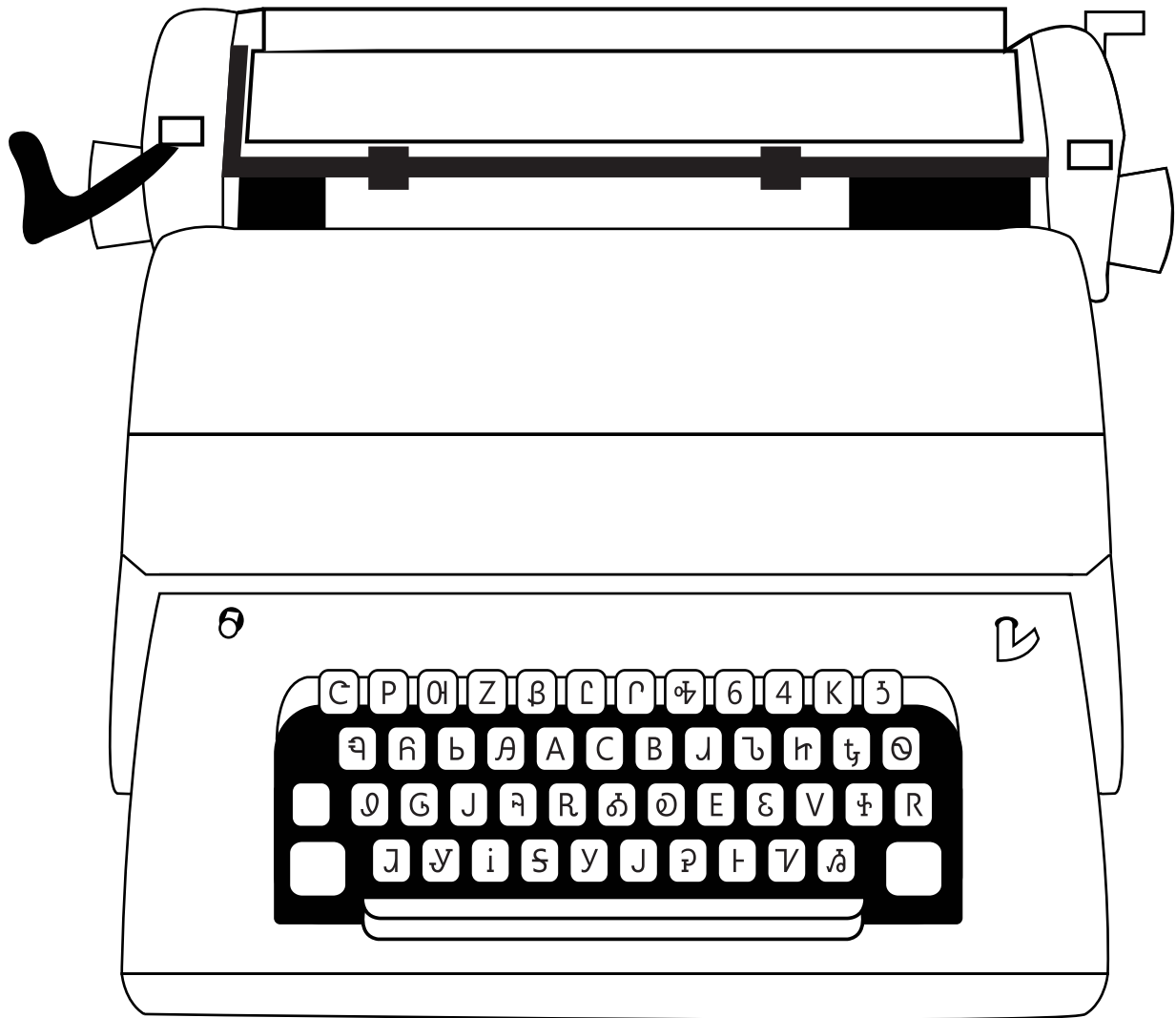

**DhCWY ӨG˘T hR hLEGŁđOŁ ӨLV P
bӨWhT ǎOŁOY ӨөөY JđBŁөөY Dđ
đӨRZPJT. ƒT bӨWhT O'MhPY, ӨөөYӨ
JAđGJ JƒOŁөөVJ, Dđ TYӨhAөөJ ӨөөY
OŁŁCBRY.**

Connect the Dots

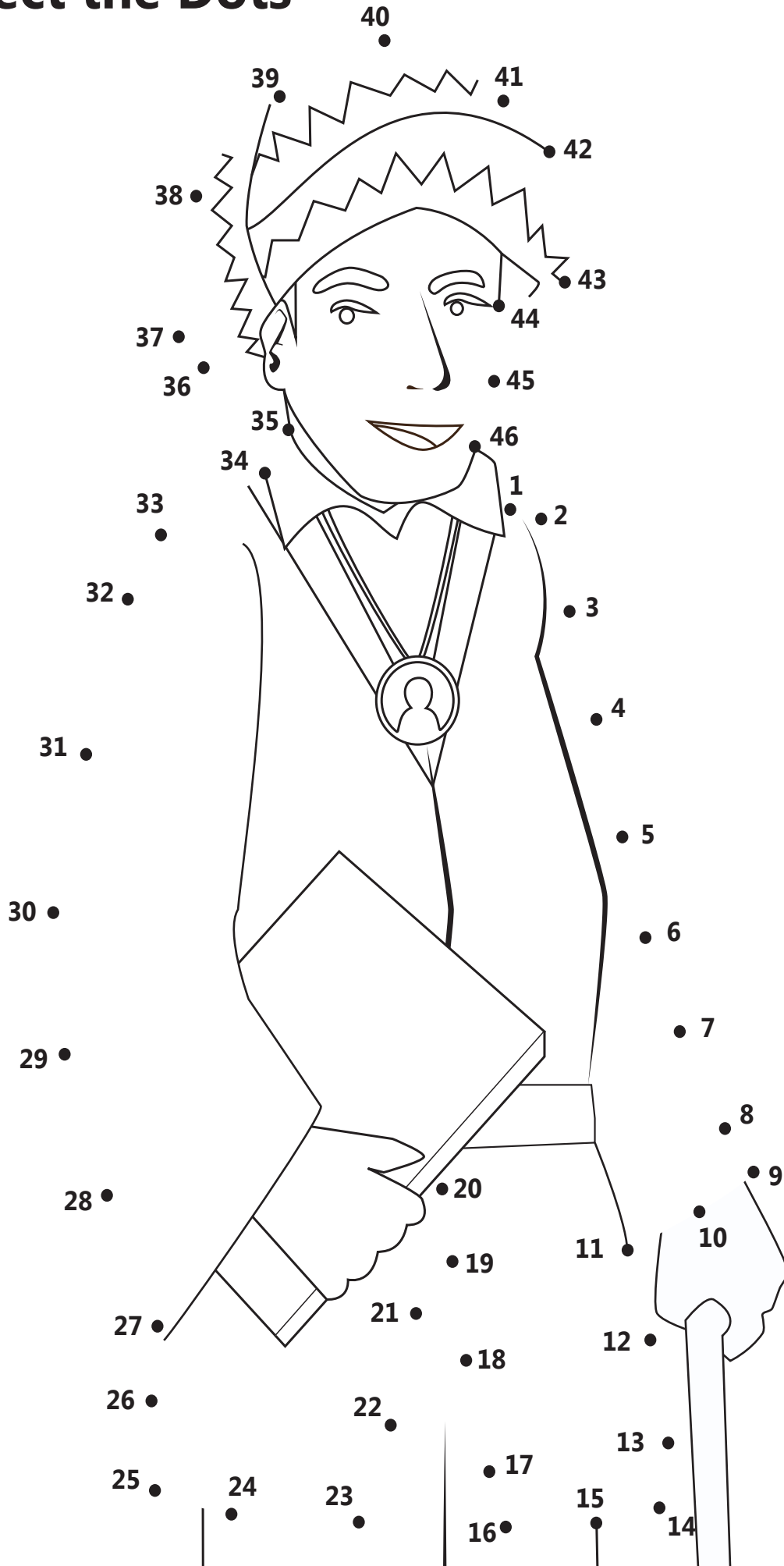

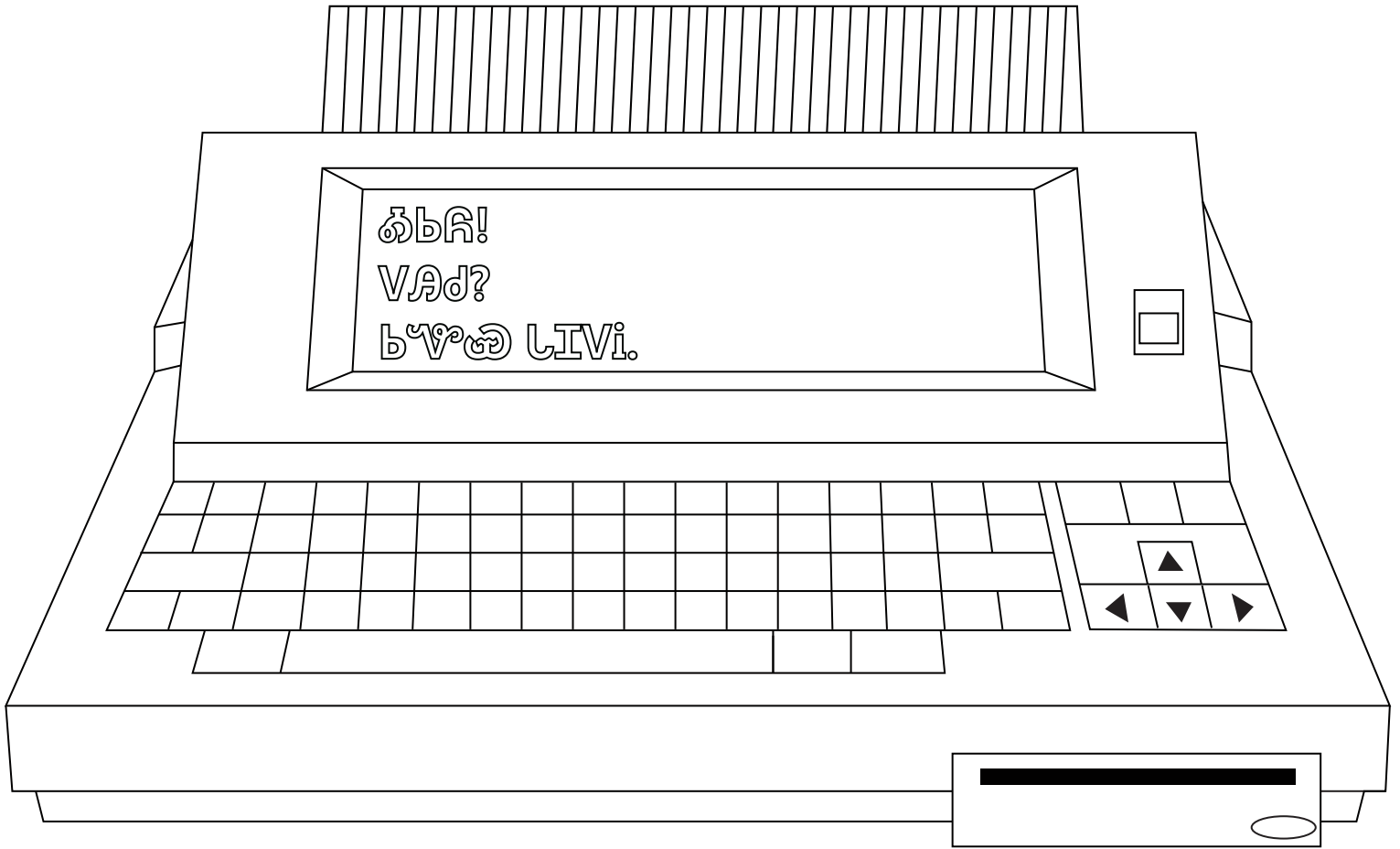

**1980's ኩባንሪ ፕሮጀክት ለግብርና ግብርና ግብርና.
ግብርና ግብርና ግብርና ግብርና. ግብርና
ግብርና ግብርና ግብርና ግብርና ግብርና ግብርና
ግብርና ግብርና ግብርና ግብርና ግብርና ግብርና.**

Connect the Dots

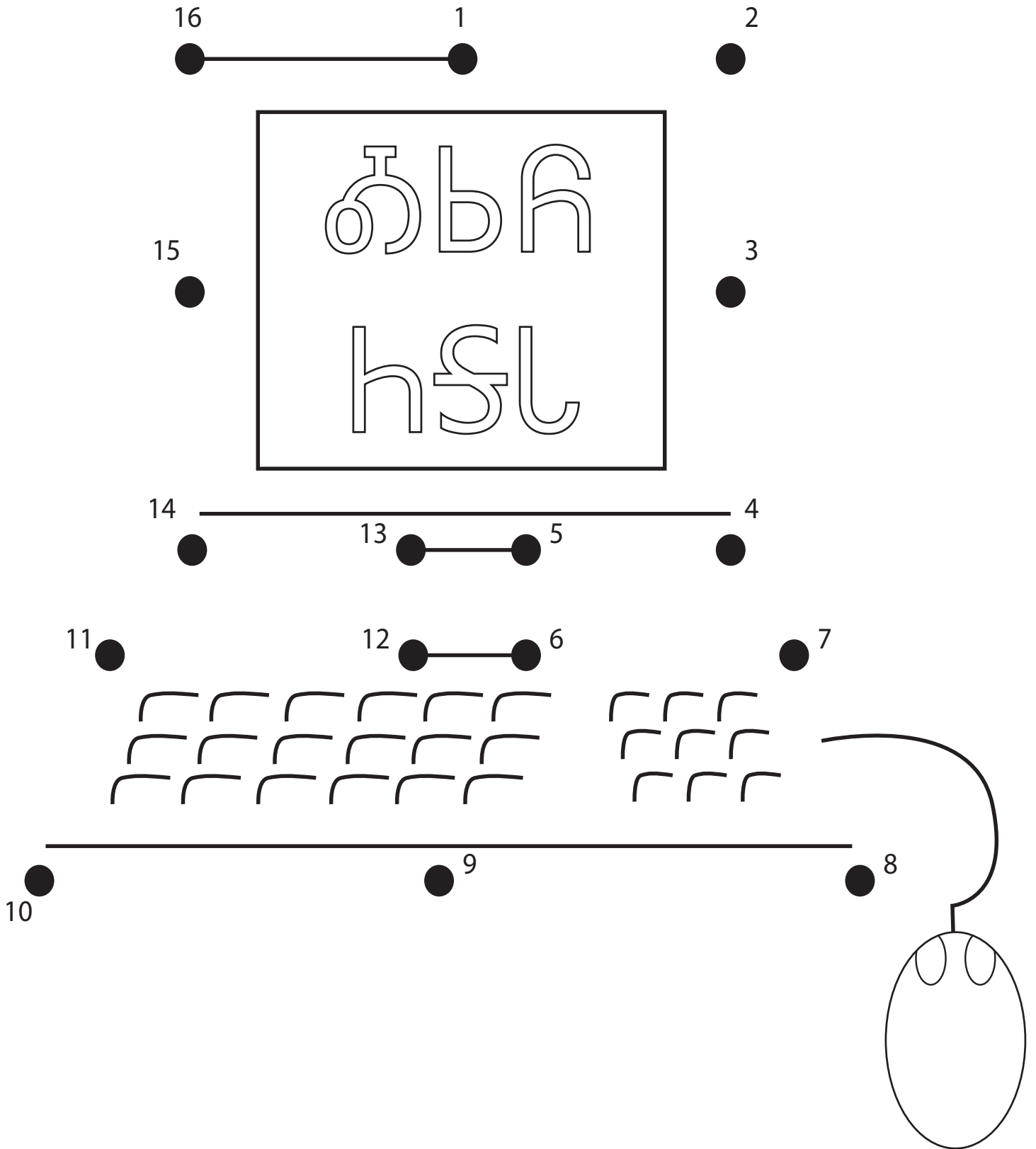

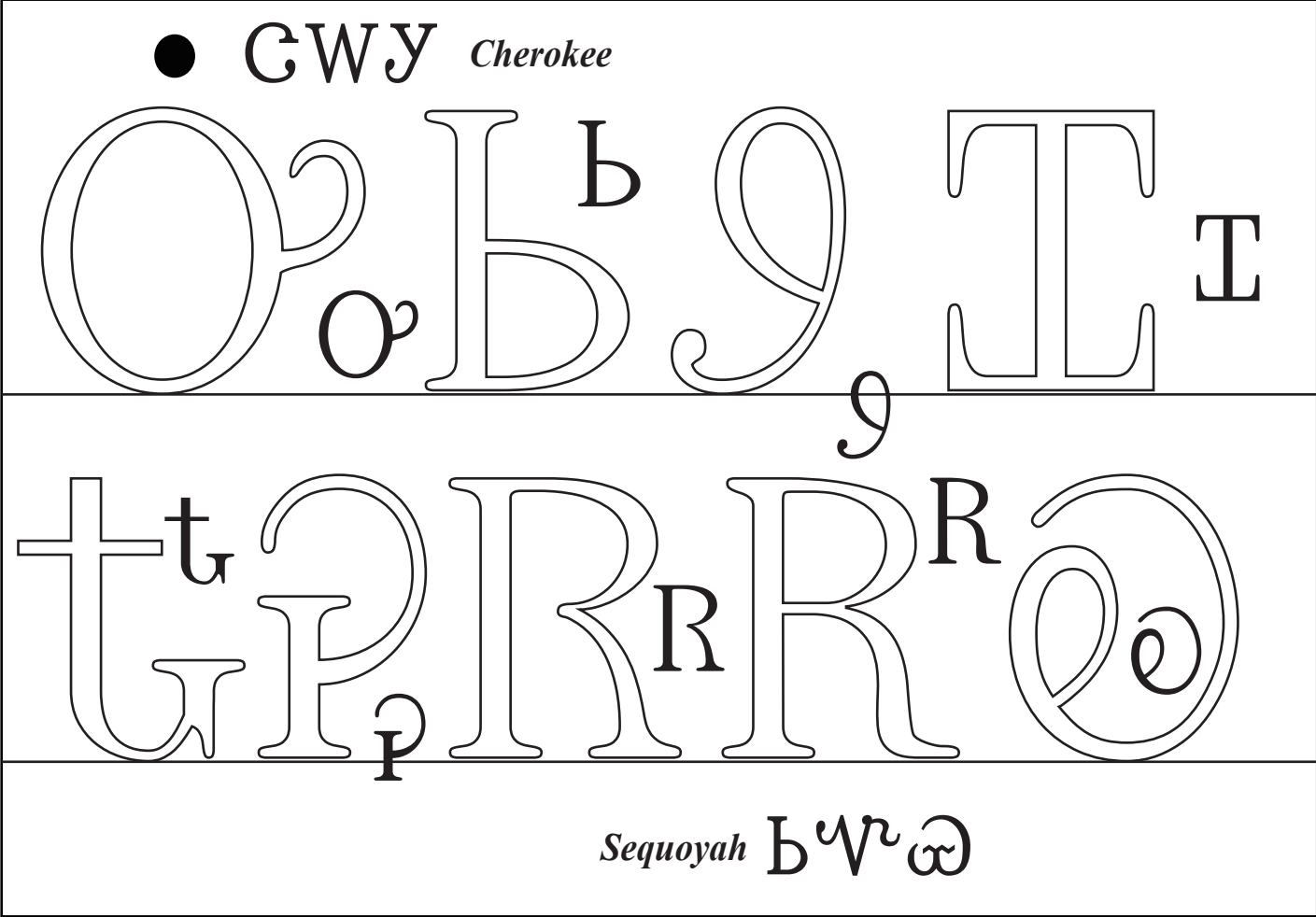

1990's DEႃႆႃႆ Ⴀႃႆႃႆ, DSViႃႆႃႆႃႆႃႆႃႆႃႆ
 Ⴀႃႆႃႆႃႆႃႆႃႆႃႆႃႆႃႆႃႆႃႆႃႆ, KT
 ႃႆႃႆႃႆႃႆႃႆႃႆႃႆႃႆႃႆႃႆႃႆႃႆႃႆႃႆႃႆႃႆႃႆႃႆ.
 Zႃႆႃႆႃႆႃႆႃႆႃႆႃႆႃႆႃႆႃႆႃႆႃႆႃႆႃႆႃႆႃႆႃႆႃႆ
 Ⴀႃႆႃႆႃႆႃႆႃႆႃႆႃႆႃႆႃႆႃႆႃႆႃႆႃႆႃႆႃႆႃႆႃႆ.

Fill In The Missing Syllabary Character

1. 丿__W__T

6. ㄷ__y ㄱ__A__O^u__

2. D^S__iA__J

7. J__ㄹ__J__Z__S

D__Ih__J__y

8. J__δB__O^uy A__r

3. __ㄴ^o__

9. J__ㄹ__J

4. ㄱ__r__P__

__ㄷ^o__ㄱ

5. h__S__

10. __v__r__y

How many words can you create out of:

Technology Supports Cherokee

1.	_____
2.	_____
3.	_____
4.	_____
5.	_____
6.	_____
7.	_____
8.	_____
9.	_____
10.	_____
11.	_____
12.	_____
13.	_____
14.	_____
15.	_____

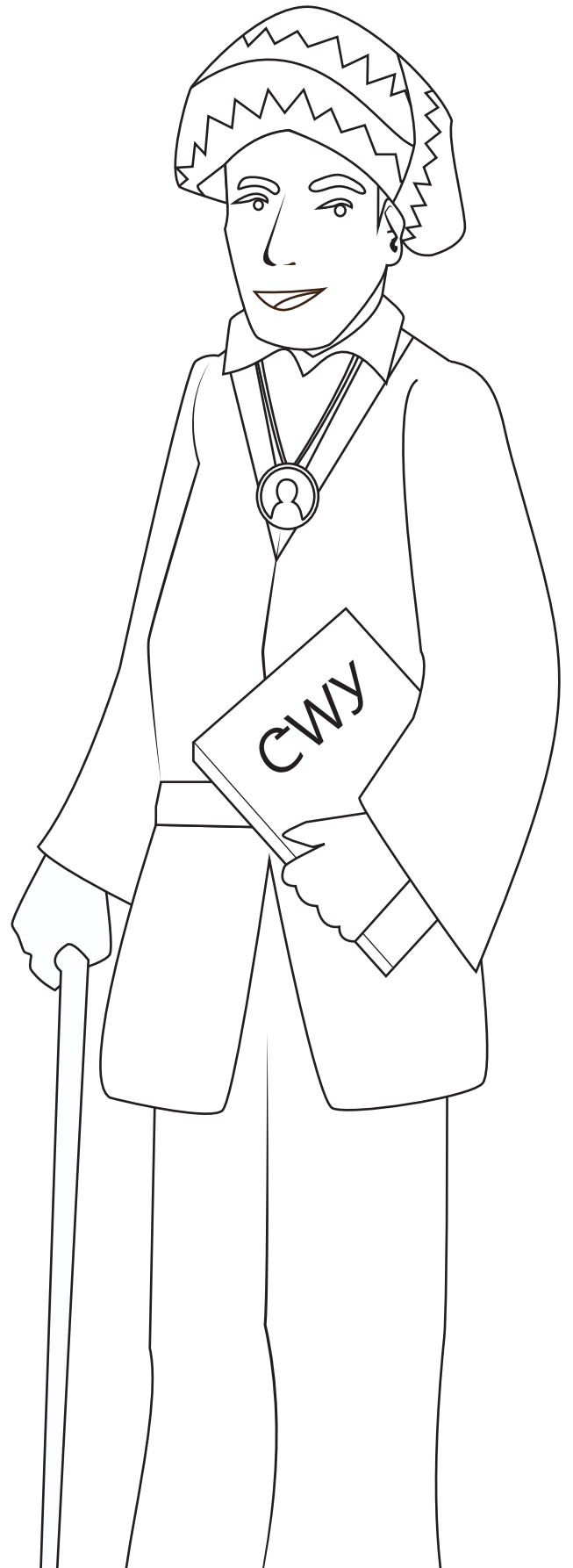

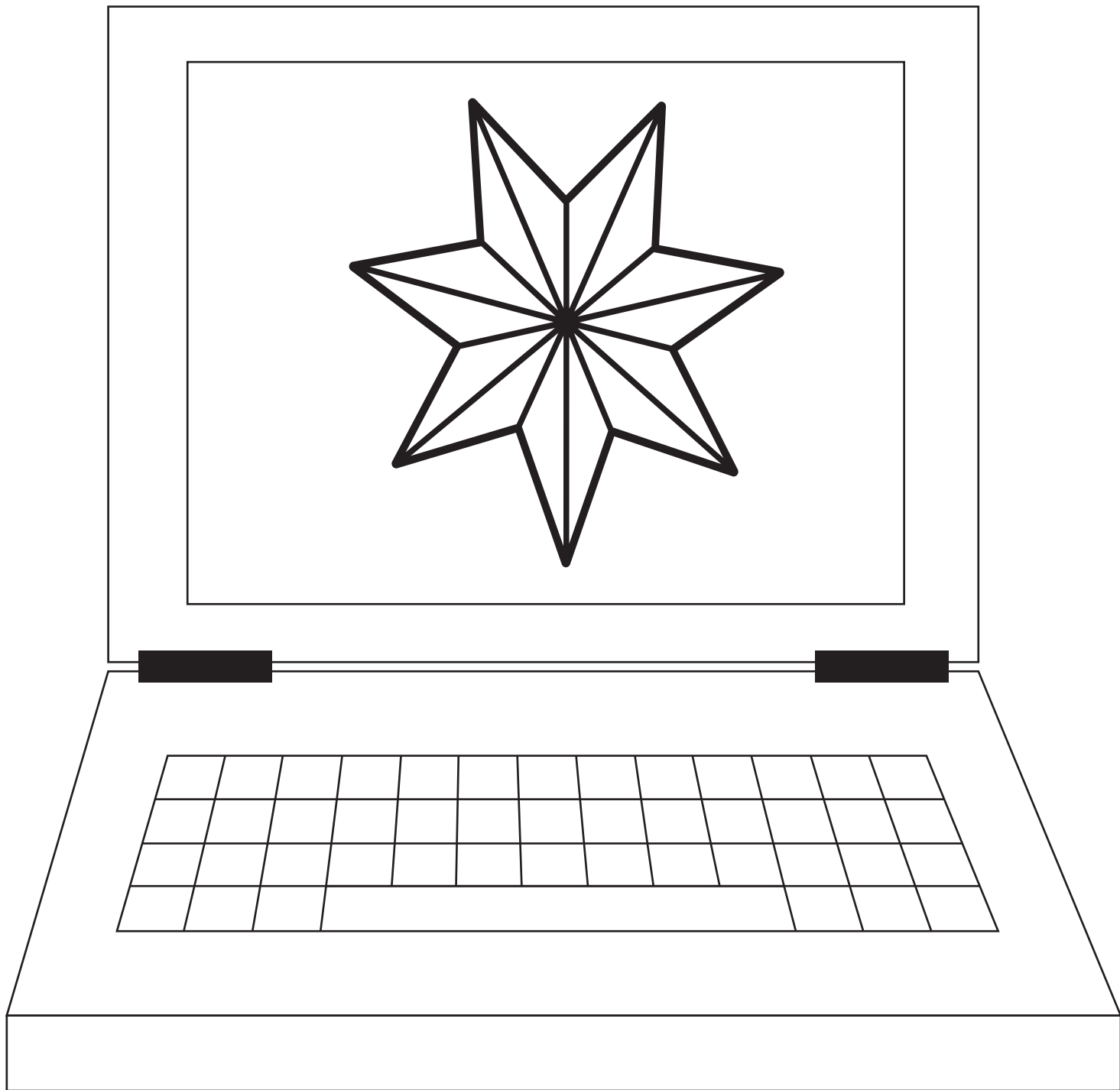

**DSViAᄁᄁ DᄁIhAᄁᄁᄁ Tᄁᄁᄁᄁ ᄁᄁᄁᄁᄁᄁᄁ,
ᄁᄁᄁᄁ ᄁᄁᄁᄁᄁᄁᄁ Tᄁᄁᄁᄁ DSViAᄁᄁᄁ DᄁᄁIhAᄁᄁᄁᄁ
ᄁᄁᄁᄁᄁᄁ, ᄁᄁᄁᄁ ᄁᄁᄁᄁᄁᄁ ᄁᄁᄁᄁᄁᄁ ᄁᄁᄁᄁ ᄁᄁᄁ
ᄁᄁᄁᄁᄁ. Dhᄁᄁᄁᄁ ᄁᄁᄁᄁᄁᄁᄁᄁᄁ ᄁᄁᄁᄁᄁᄁᄁ
ᄁᄁᄁᄁᄁᄁ Dhᄁᄁᄁᄁᄁᄁ.**

Glossary

1. Technology - ጌፀWኩፐ
2. Computer - ልፍፕላይኔት ልፍፕላይኔት
3. Sequoyah - ጌኖኔ
4. Phone - ልፀሮፖ
5. Mouse - ኩፐፍኩ
6. Cherokee Phoenix - ሮዌይ ልፍፕላይኔት
7. Syllabary - ጋላግጋ ልፖፍ
8. Newspaper - ጋፍፕፕር ልግፍ
9. Typewriter - ጋላግጋ ጋፍፕፕር
10. Font - ጋፕፕር

Answers

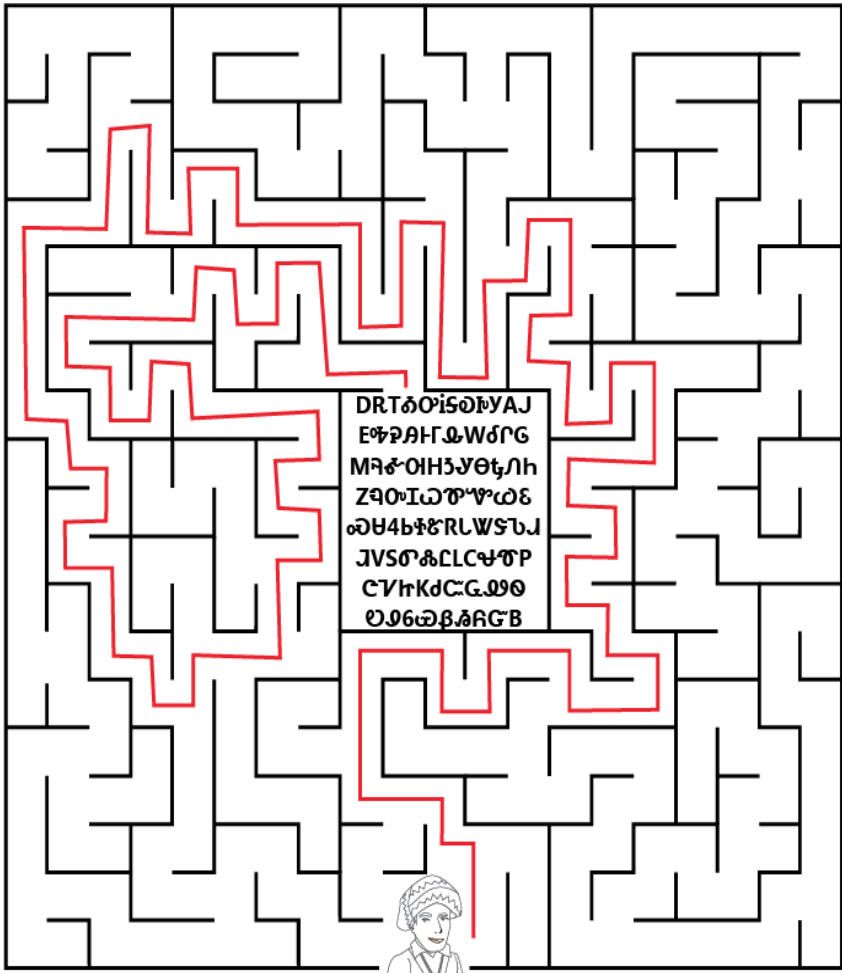

DRጥዕናውየሃገሩ
 የቅዱስቤቱወሰን
 ጠቅላይ ስራ ጋብቻ
 ደብዳቤውሆነው
 የሆኑት ገለጻቸው
 ገረማዎች ገረማዎች
 ለሀገር ገረማዎች



ገረማዎች

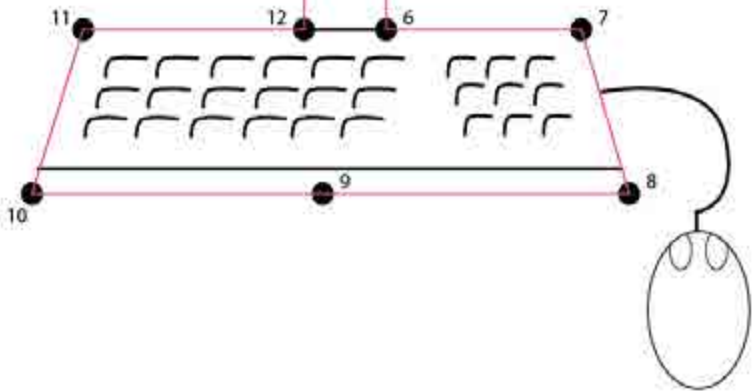
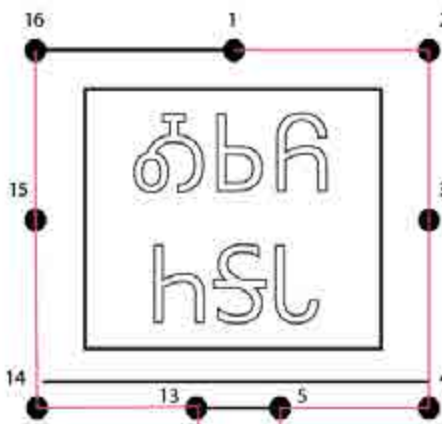
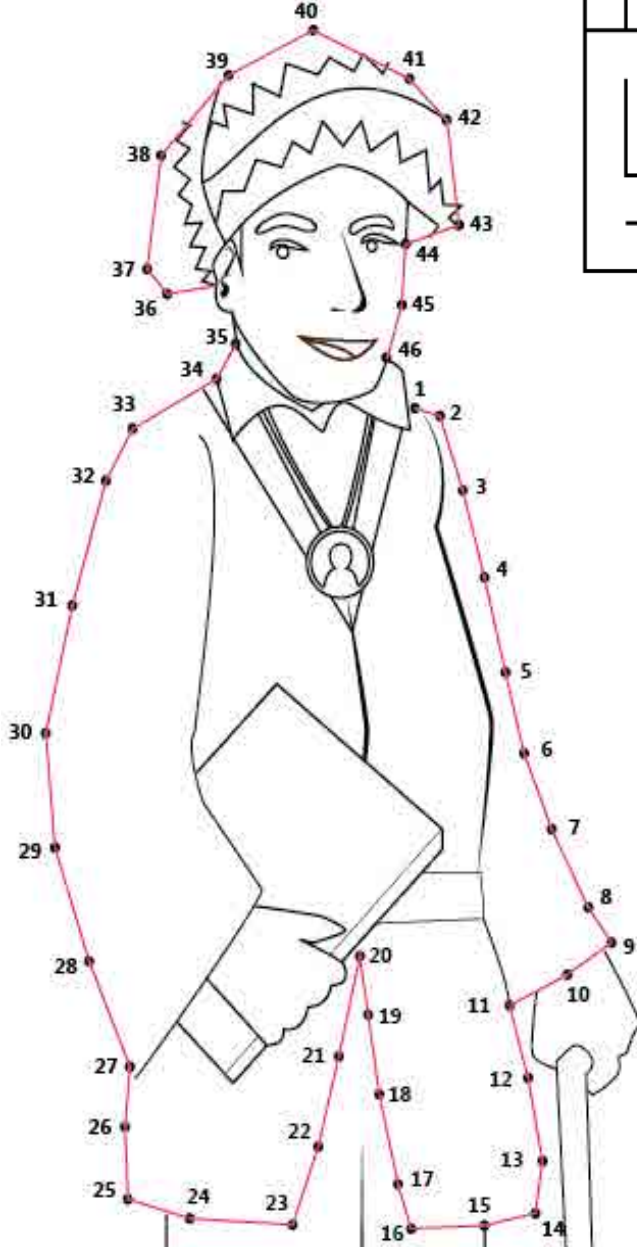

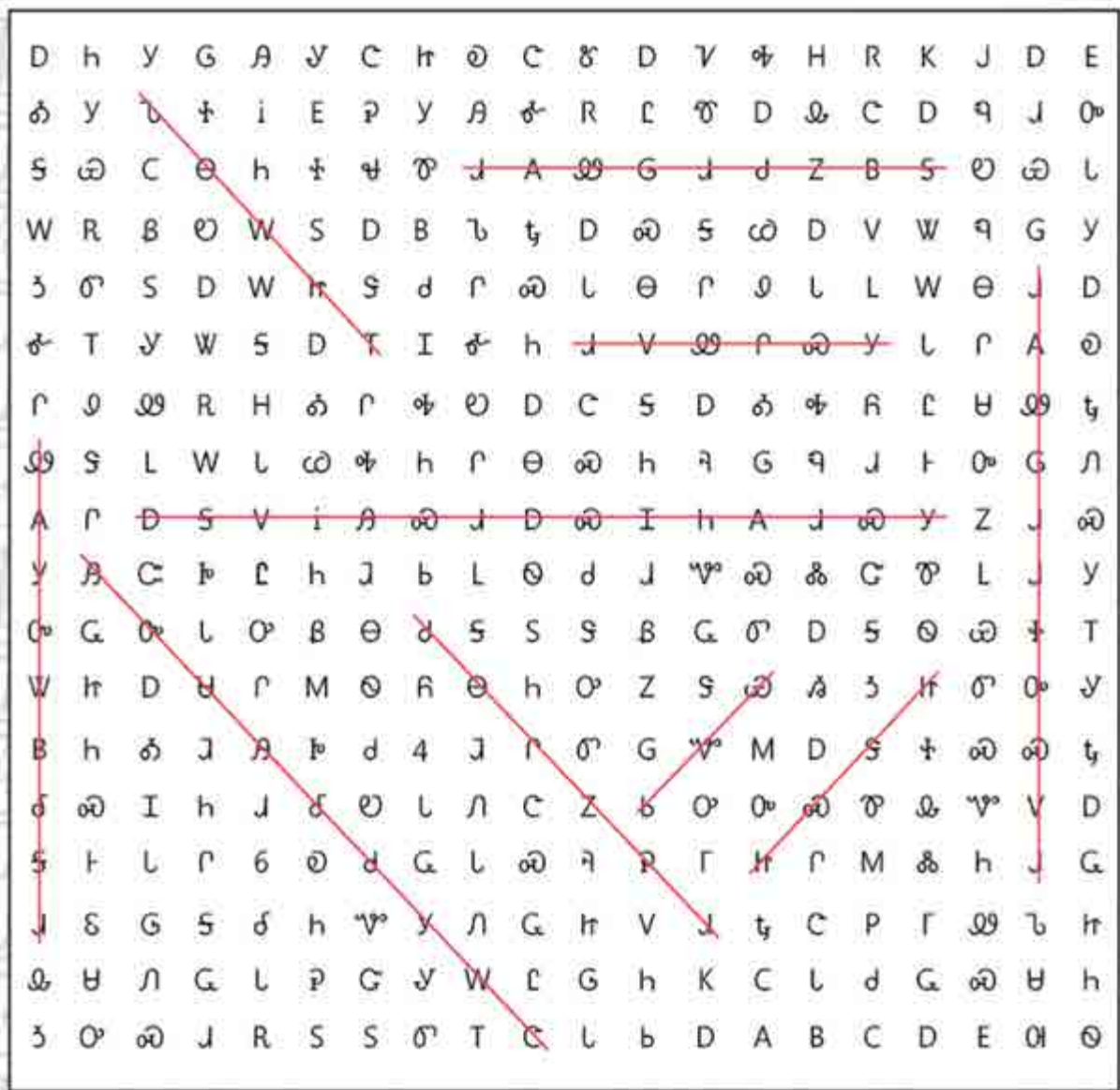

1. Technology - ጌፀWፎT
2. Computer - DፍViፆፅJ DፅፅIፆAፆፅY
3. Sequoyah - ፆ፶፵ፅ
4. Phone - ፅፀፆፆፆJ
5. Mouse - ፆፆፆፆፆ
6. Cherokee Phoenix - ፆWY ፅፆፆፆፆፆ
7. Syllabary - JAፆፆፆፆ ፅZBS
8. Newspaper - JፆፆፆWፆፆፆፆ Aፆፆፆ
9. Typewriter - JAፆፆፆፆ ፆፆፆፆፆፆፆፆ
10. Font - JVፆፆፆፆፆፆፆፆ

About The Authors

Translator- John Ross is a Translation Specialist for Cherokee Nation Education Services. A full-blood bilingual Cherokee, John grew up in Greasy, OK. He is recognized as a Cherokee National Treasure for his dedication to the Cherokee Language. John has five children and five grandchildren and is married to Julie Kiddy Ross. He is a member of First Baptist Church Fort Gibson. This book is about the development of the Cherokee syllabary.

Illustrator- Jeff Edwards is an award winning graphic artist and grew up in Vian, OK. He is a Language Technologist for Cherokee Nation Education Services.

ᏍᏍᏍᏍ ᏍᏍᏍᏍ

CHEROKEE NATION®

P.O. Box 948

Tahlequah, OK 74465-0948

918-453-5000

www.cherokee.org

© Cherokee Nation. All Rights Reserved.